

CTC
TTC



OPERATING MANUAL

Climatic test chamber CTC 256
Temperature test chamber TTC 256

Manufacturer and customer service

MEMMERT GmbH + Co. KG
Postfach 17 20
D-91107 Schwabach

Äußere Rittersbacherstr. 38
D-91126 Schwabach
Germany

Fon: +49 (0) 09122 / 925-0
Fax: +49 (0) 09122 / 14585
E-Mail: sales@memmert.com
Internet: www.memmert.com

Customer service:

Fon: +49 (0) 09122/925-128
and: +49 (0) 09122/925-126
E-Mail: service@memmert.com

For service enquiries, please always specify the appliance number on the nameplate (see page 16).

© 2018 Memmert GmbH + Co. KG

Edition 02/2018

Subject to modifications

About this manual

Purpose and target group

This manual describes the setup, function, transport, operation and maintenance of temperature test chambers of the type TTC 256 and climatic test chambers of the type CTC 256. It is intended for use by the trained staff of the operator who are in charge of operating and / or maintaining the test chamber.

If you as the operator are asked to work on the test chamber, you should read this manual carefully before starting work on the unit. Familiarise yourself with the safety regulations. Only perform the work that is described in this manual.

If there is something you don't understand, or certain information is missing, ask your superior or get in touch with the manufacturer. Do not do anything without authorisation.

i The descriptions in this manual concerning the humidity/climatic processes refer to the CTC climatic test chambers. TTC temperature test chambers have no humidity controller, so that the corresponding sections of this manual are not relevant for these device types.

Other documents to observe:

- ▶ for service and repair work (see page 64): the separate service manual
- ▶ for controlling the test chamber with the Memmert-PC software "Celsius" (see page 43) the separate manual "Celsius"
- ▶ Calibration documents; which can be found in the document compartment in the water tank drawer (see page 10)

Storage and Forwarding

This instruction manual belongs with the test chamber and should always be stored so that those persons who work on the test chamber have access to it. It is the responsibility of the operator to ensure that persons who are working on or who will work on the test chamber are informed as to the whereabouts of this instruction manual. We recommend that it is always stored in a protected location close to the test chamber.

Make sure that the instruction manual is not damaged by heat or damp.

If the test chamber is sold on or transported and then set up again at a different location, this instruction manual must also go with it.

Content

1. Safety regulations	6
1.1 Terms and symbols used	6
1.1.1 Terms used	6
1.1.2 Symbols used	6
1.2 Product safety and dangers	7
1.3 Safety Labelling	7
1.4 Requirements of the operating personnel	8
1.5 Responsibility of the owner	8
1.6 Changes and conversions	8
1.7 Behaviour in case of malfunctions and irregularities	8
1.8 What to do in case of accidents	9
1.9 Switching off test chamber in an emergency	9
2. Design and description	10
2.1 Design	10
2.2 Description	11
2.2.1 Temperature operation	11
2.2.2 Humidity operation (only CTC climatic test chamber)	11
2.3 Working range	12
2.4 Basic equipment	13
2.5 Material	14
2.6 Intended Use	14
2.7 EC Declaration of Conformity	15
2.8 Designation (nameplate)	16
2.9 Technical data	17
2.10 Environmental conditions	18
2.11 Connections	18
2.12 Standard accessories	18
3. Delivery, Transport and Setting Up	19
3.1 Safety Regulations	19
3.2 Delivery	19
3.2.1 Unpacking	19
3.2.2 Checking for completeness and transport damage	19
3.2.3 Disposing of packaging material	19
3.3 Storage after delivery	19
3.4 Transport	20
3.5 Installation	20
4. Putting into Operation	21
4.1 Checking the door and adjusting if necessary	21
4.2 Checking the temperature sensors	21
4.3 Install and connect laptop (optional)	21
4.4 Filling the freshwater tanks	22
4.5 Connecting	23
5. Operation and control	24
5.1 Operating staff	24
5.2 General information on operation	24
5.3 Before starting	24
5.4 Opening and closing the door	25
5.4.1 Opening and closing the door with high and low temperatures	25
5.5 Loading the test chamber	26

5.6	Basic operating information.....	27
5.6.1	Switching appliance on and off	27
5.6.2	Operating panel/ controller	28
5.6.3	Basic operation	29
5.6.4	Setting parameters	29
5.7	Operating modes.....	29
5.8	Operating mode - settings	30
5.8.1	Normal mode	30
5.8.2	Example setting Normal mode.....	31
5.8.3	Week time switch	33
5.8.4	Example of settings Week time switch	34
5.8.5	Programming mode	35
5.8.6	Close commands for ramp segments	37
5.8.7	Example setting programming mode.....	39
5.8.8	Operation with PC/laptop (optional).....	43
5.9	Ending operation.....	43
6.	Malfunctions and error messages	44
6.1	Error in the temperature monitoring / humidity system	44
6.2	System/ appliance errors	44
6.3	Power failure.....	45
7.	Advanced functions	46
7.1	Printer	46
7.2	Basic appliance settings (Setup).....	46
7.3	Temperature monitoring and safety equipment.....	48
7.3.1	Electronic temperature monitoring (TWW)	48
7.3.2	Automatic temperature monitor (ASF)	49
7.3.3	Warning messages	51
7.3.4	Safety and monitoring equipment for the cooling unit	51
7.4	Calibration	51
7.4.1	Temperature calibration	51
7.4.2	Humidity calibration (only for CTC 256).....	53
7.5	Automatic defrosting system	54
7.6	Communication interfaces	55
7.6.1	USB interface	55
7.6.2	Communication interfaces RS232/RS485 (optional).....	55
7.6.3	Connection of test chambers to a network with Ethernet interface	56
7.6.4	Log memory	57
7.6.5	MEMoryCard XL	58
7.6.6	User ID card (optionally available as an accessory).....	60
8.	Maintenance and Servicing	61
8.1	Basic cleaning	61
8.2	Intensive cleaning	61
8.3	Regular maintenance	62
8.4	Adjust door.....	63
8.5	Removing / cleaning the air filter of the cooling unit	63
8.6	Replacing the interior lamps	64
8.7	Repairs and Service.....	64
9.	Storage and disposal	65
9.1	Storage	65
9.2	Disposal	65
	Index	66

1. Safety regulations

1.1 Terms and symbols used















In this manual, certain common terms and symbols are used to warn you of dangers or to give you hints that are important in avoiding injury or damage. Observe and follow these hints and regulations to avoid accidents and damage. These terms and symbols are explained below.

1.1.1 Terms used

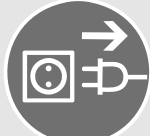
„Warning“ is used whenever you or somebody else could be injured if you do not observe the accompanying safety regulation.

„Caution“ is used for information that is important for avoiding damage.

1.1.2 Symbols used

Prohibition sign (forbidding an action)					
	Do not tilt appliance		Do not lift appliance		Do not stack appliance
Warning symbols (warning of a danger)					
	Danger of electric shock		Explosive atmosphere		Cold/danger of frostbite
	Heat/hot surface/danger of burning		Danger of hot vapours/scalding		Dangerous gases/vapours
Regulation signs (stipulate an action)					
	Disconnect the mains plug		Wear gloves		Wear safety shoes
	Observe information in separate manual				
Other symbols					
	Information on first aid		Important or useful additional information		

1.2 Product safety and dangers

Temperature test chambers of type TTC and climatic test chambers of type CTC are technically advanced, manufactured using high-quality materials and are tested for many hours in the factory. The test chambers are state-of-the-art technology and comply with recognised technical safety regulations. However, there are still dangers involved, even when the appliance is used as intended. These dangers are described below.



Warning!

When opening the chamber door, hot steam may escape and scald you. Remain behind the door when you open it and let out the steam, or allow the test chamber to cool down before opening the door.



Warning!

Depending on operation, the surfaces in the chamber interior, the viewing window, the cable feed-through and the chamber load may be very hot or very cold. You could suffer from burns or frostbite if you touch these surfaces. Allow the chamber interior to first adjust to room temperature after opening the door, or use heat-resistant protective gloves.



Warning!

After removing covers, voltage-carrying parts may be exposed. You may receive an electric shock if you touch these parts. Disconnect the mains plug before removing any covers.

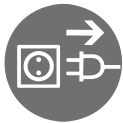

Any work inside the unit may only be performed by qualified electricians.



Warning!

When loading the chamber with an unsuitable load, toxic or explosive vapours or gases may be produced. This could cause the chamber to explode, and people could be badly injured or poisoned. The chamber may only be loaded with materials/test objects which do not form any toxic or explosive vapours when heated up (see also chapter 2.6 Intended Use on page 14).



1.3 Safety Labelling

The test chamber is provided with warning stickers on the door to warn of dangerous temperatures inside the chamber interior (Fig. 1). These stickers must not be removed and must always be well visible. If they become unrecognisable or if they peel off, they must be replaced. You can order the stickers from Memmert customer service.

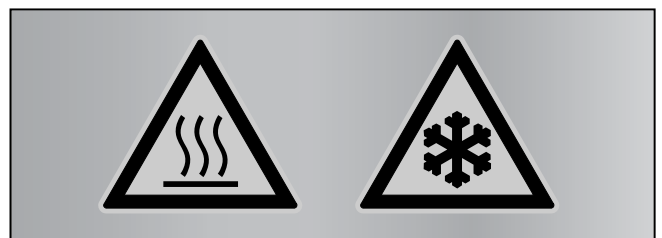

Fig. 1
Warning stickers

1.4 Requirements of the operating personnel

The test chamber may only be operated and maintained by persons who are of legal age, and who have received instructions for the test chamber. Personnel who are to be instructed or who are undergoing general training may only work with the test chamber under the continuous supervision of an experienced person.

The test chamber may only be transported by persons (with fork-lift trucks, manual pallet jacks), who are trained for this work and who know the corresponding safety regulations.

Repairs may only be performed by qualified electricians. The regulations in the separate service manual must be observed.

1.5 Responsibility of the owner

The owner of the test chamber

- ▶ is responsible for the flawless condition of the test chamber and for the test chamber being operated in accordance with its intended use (see page 14);
- ▶ is responsible for ensuring that persons who are to operate or service the test chamber are qualified to do this, have received instructions about the test chamber and are familiar with this operating manual;
- ▶ is responsible for ensuring that the safety label on the test chamber (see Chapter 1.3) is visible at all times;
- ▶ must know about the applicable regulations, requirements and work protection regulations, and train staff accordingly;
- ▶ is responsible for ensuring that unauthorised persons have no access to the test chamber;
- ▶ is responsible for ensuring that the maintenance plan is adhered to and that maintenance work is properly carried out (see page 61);
- ▶ ensures, for example through corresponding instructions and inspections, that the test chamber and its surroundings are kept clean and tidy;
- ▶ is responsible for ensuring that personal protective clothing is worn by operating personnel, e.g. work clothes, safety shoes, and protective gloves.

1.6 Changes and conversions

No independent conversions or alterations may be made to the test chamber. No parts may be added or inserted which have not been approved by the manufacturer.

Independent conversions or alterations result in the EC declaration of conformity (see page 15) losing its validity, and the test chamber may no longer be operated.

The manufacturer is not liable for any damage, danger or injuries that result from independent conversions or alterations, or from non-observation of the regulations in this manual.

1.7 Behaviour in case of malfunctions and irregularities

The test chamber may only be used when in a flawless condition. If you as the operator notice irregularities, malfunctions or damage, immediately put the test chamber out of service (see Chapter 1.9) and inform your superior.

i You can find information on eliminating malfunctions from page 44.

1.8 What to do in case of accidents



1. Keep calm. Act resolutely and with consideration. Pay attention to your own safety.
2. Switch off test chamber.
3. Call a doctor.
4. Initiate first aid measures. If available: Call a trained first aid helper.

1.9 Switching off test chamber in an emergency

Push main switch on front side of appliance (Fig. 2). This causes the test chamber to switch off.

Remember that the inside of the chamber may still be very hot or very cold even after it has been switched off, and that there may still be hot steam inside the chamber.

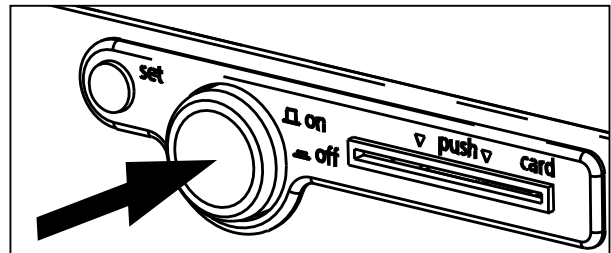

Fig. 2
Switching off test chamber by pressing main switch

2. Design and description

2.1 Design

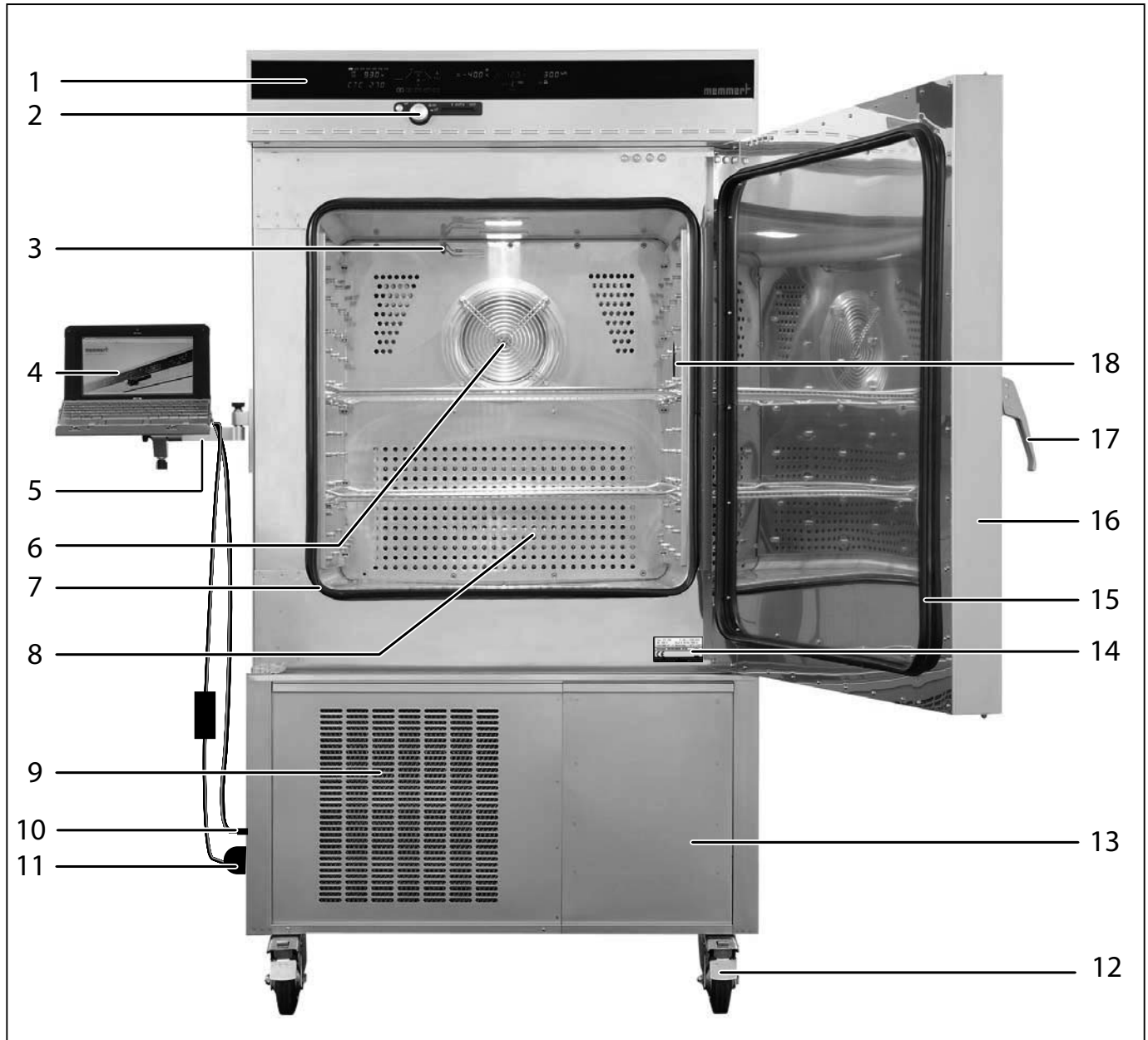

Fig. 3 Design of TTC temperature test chambers and CTC climatic test chambers

- | | |
|---|---|
| 1 Controller/operating panel (see page 28) | 11 Additional socket 230 volt/max. 5 amp. (see also Fig. 4) |
| 2 Main switch / push-turn control (see page 27) | 12 Locking swivel castors |
| 3 Temperature sensor (see page 21) | 13 Drawer for water tank with document compartment (only for CTC climatic test chambers, see page 22) |
| 4 Laptop (optional) (see pages 21 and 43) | 14 Nameplate (see page 16) |
| 5 Laptop holder (special accessories, see page 21) | 15 Door seal |
| 6 Chamber fan | 16 Door |
| 7 Chamber seal | 17 Handle to open and close door (see page 25) |
| 8 Interior for chamber load | 18 Side feed-through to chamber, 80 mm diameter |
| 9 Fan/air filter of cooling unit (see page 63) | |
| 10 USB connection/ communication interfaces (see also Fig. 4 and page 55) | |

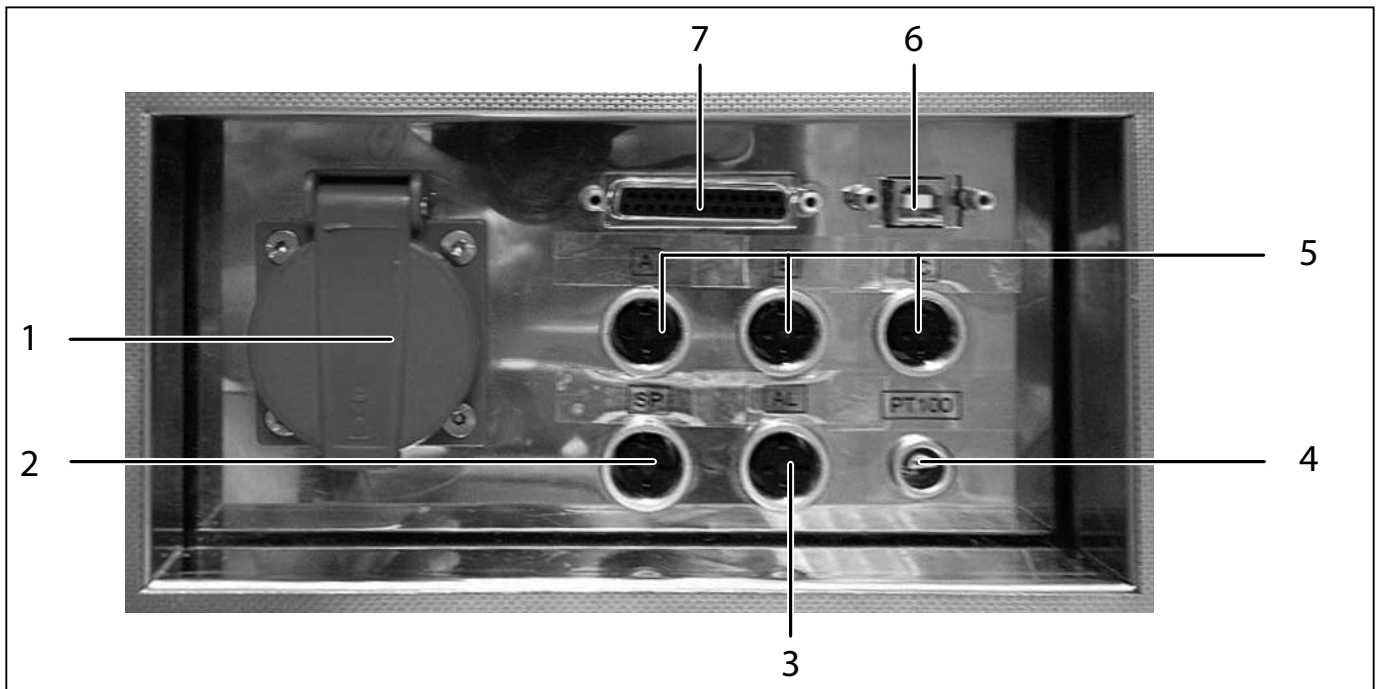

Fig. 4 Connection panel at bottom left of appliance base (see Fig. 3, Items 10 and 11)

- 1 Socket 230 volt/max. 5 A
- 2 Floating switch contact SP = setpoint reached for message that the temperature in the chamber lies within a tolerance range of ± 2 K. Load capacity 24 volt/2 amp. (optional)
- 3 Floating switch contact alarm for error display. Load capacity 24 volt/2 amp. (optional)
- 4 Additional freely positionable Pt100 temperature sensor (optional)
- 5 Floating switch contacts A, B and C, can be switched, depending on programme, via "Celsius" software. Load capacity 24 volt/2 amp. (optional)
- 6 USB interface
- 7 Parallel printer port

2.2 Description

2.2.1 Temperature operation

The test chamber can heat the interior up to 190 °C and cool it down to -42 °C.

To avoid condensation in the interior, the appliance has various heating systems:

- ▶ low-voltage door frame and seal heating, contacted via door contacts
- ▶ condensation water outlet pipe heating
- ▶ heated glass sheet and glass frame heating (only for the glass door option)

The temperature is lowered through an integrated cooling unit.

2.2.2 Humidity operation (only CTC climatic test chamber)

The CTC climatic test chamber can in addition lower humidity in the chamber to 10 % rh or increase it to up to 98 % rh. Humidification takes place via a PTC hot steam generator.

The amount of steam is controlled by two self-priming tube dosing pumps.

Dehumidification takes place through controlled cooling the evaporator temperature below the dew point.

Humidity measuring takes place via a temperature-resistant capacitive humidity sensor.

The humidity setpoint can be adjusted within the range 10 to 98 % rh. If a humidity setpoint of 0 % rh is set, the humidification and dehumidification control is completely deactivated.

Important: The relative air humidity can only be set in the temperature range of 10 °C to 95 °C. The CTC climatic test chamber has two freshwater tanks with automatic switchover (see page 22). The currently active tank is indicated in the control display by "TANK1" or "TANK2" (see page 28).

2.3 Working range

i Caution: If in operation at the upper level or outside the working range for long periods, puddles of water may form inside the chamber and water may pass the door seal.

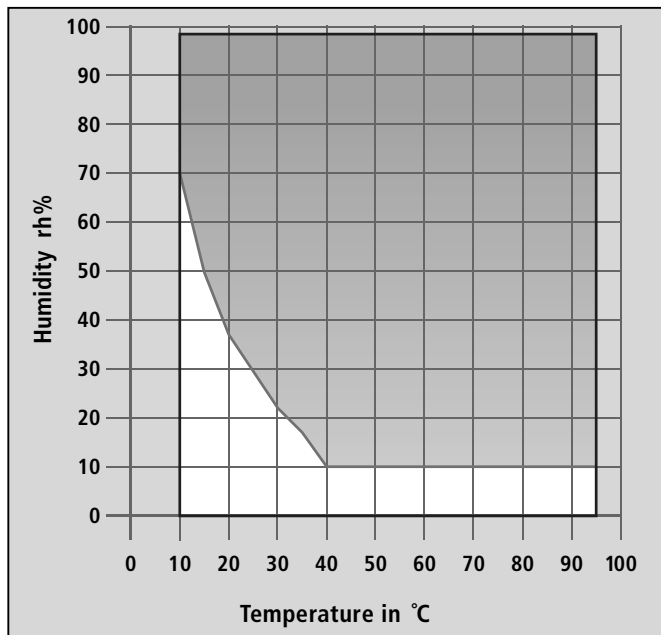

Fig. 5 Control range of temperature and relative humidity

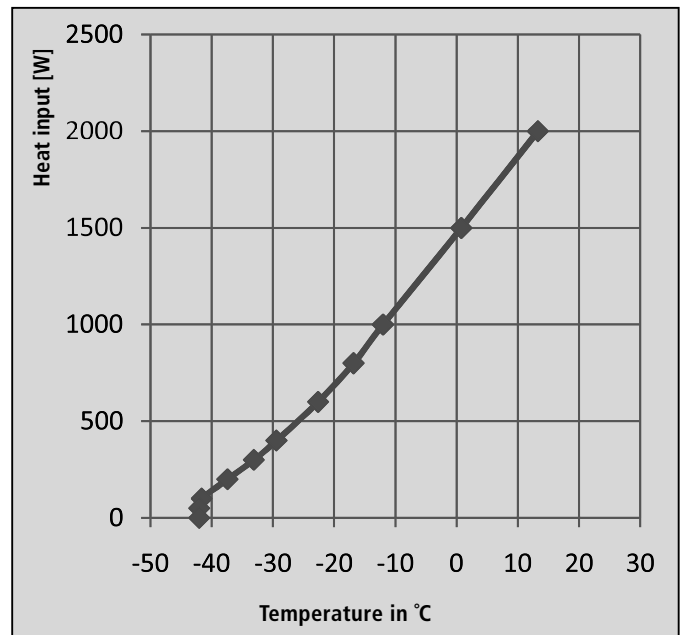

Fig. 6 Heat compensation $T_{ambient} = 25\text{ °C}$

2.3.1 Temperature change rate

The temperature change rate (K/min) is the time the appliance needs to heat up from -18 °C to 158 °C or to cool down from 158 °C to -18 °C (Fig. 7).

In order to determine the appliance-specific temperature change rate, a calibrated reference instrument is needed. Its sensor is placed in the middle of the appliance's interior.

1. Set the temperature to -40 °C and wait until the appliance has cooled down completely (recommendation: 2 hours).
2. Set the temperature to 180 °C and then measure the time between the 10% and 90%-marks of the overall temperature range of 220 K (i.e. from -18 °C to 158 °C).
3. After the temperature has stabilised (in around 30 minutes), set it back to -40 °C and then measure the time between the 90% and 10%-marks of the temperature range (i.e. from 158 °C to -18 °C).

The cooling down speed and heating up speed is 176K divided by the respectively measured time in minutes (K/min).

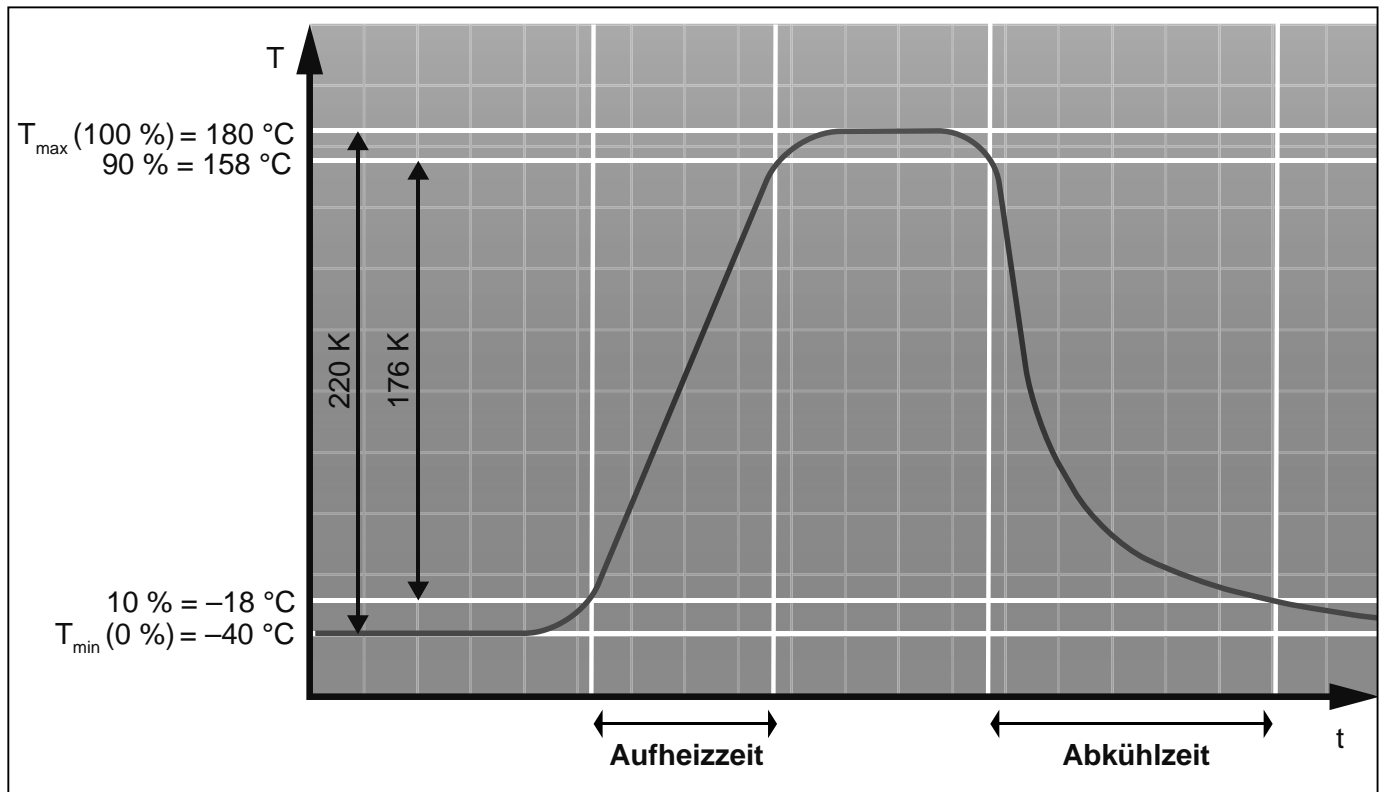

Fig. 7 Heating up speed and cooling down speed

2.4 Basic equipment

FCKW-free cooling unit with automatic hot gas defrosting device and motor-driven air circulation in the chamber

- ▶ Electronic fuzzy-supported PID process controller with permanent performance adjustments and time-saving self-diagnosis system to quickly locate errors (see chapter 6. Malfunctions and error messages on page 44)
- ▶ Alphanumeric text display (see page 28)
- ▶ Control of appliance and logging of actual values on MEMoryCard XL (see page 58)
- ▶ Programme sequence control for up to 40 ramp segments (see chapter 5.8.5 Programming mode on page 35)
- ▶ Integrated week time switch with group function (e.g. each working day) (see chapter 5.8.3 Week time switch on page 33)
- ▶ Retracting push-turn control for simple operation of appliance (see page 27)
- ▶ Acoustic warning signal when programme ends and for input acknowledgment (button click) (see page 47)
- ▶ Digital monitoring control for overtemperature, undertemperature and automatic setpoint following (automatic safety function / ASF) (see page 48)
- ▶ Two separate Pt100 temperature sensors DIN Cl. A in a 4-wire circuit for control and monitoring (see page 21)
- ▶ Parallel printer port (PCL3-compatible) (see page 46)
- ▶ USB interface (optionally Ethernet) for computer-based temperature control programmes and to read out the controller's internal log memory (see page 55)
- ▶ MEMMERT Celsius software from version V9.4 for remote control of the test chamber via computer and to read out the controller's internal log memory

- ▶ Calibration certificates for temperatures at -20 °C and $+160\text{ °C}$ and for humidity at 30 °C and 60 \% rh
- ▶ A pre-formatted empty MEMoryCard XL with a storage capacity of 32 kByte.
- ▶ Reprogrammable for up to 40 ramp segments and in addition 135 hours of log memory for temperature and humidity, with a scan interval of 1 minute (see page 58).
- ▶ Optional equipment (available separately as an accessory): External card reader for MEMory-Card XL for connection to the PC-USB interface, printer cable (parallel, shielded) 25-pin (see page 59)
- ▶ Language settings (German, English, French, Spanish, Italian) (see page 47)
- ▶ Capacitive humidity sensor (only for CTC 256)
- ▶ Active humidity control guarantees that setpoint humidity is quickly achieved, with short recovery times, and avoiding condensation formation (only for CTC 256)
- ▶ 7 different ramp close commands for sophisticated temperature control tasks (see page 38)
- ▶ Visual and acoustic warning signals if temperature or humidity limits are crossed, and if water container is empty
- ▶ Feed-through $\varnothing 80\text{ mm}$ on right with silicon sponge plug
- ▶ Internal log memory with 1024 kB as ring memory for all temperature and humidity values, errors and settings in real time and with date, logging approx. 3 months at 1 minute storage interval (see page 57)
- ▶ Calibration possible without separate computer: 3-point calibration on temperature controller and 2-point calibration for humidity at 20 \% rh and 90 \% rh (see page 51)

2.5 Material

For the outer housing, MEMMERT uses stainless steel (W.St.No. 1.4016 = ASTM 430), for the interior, stainless steel (W.St.No. 1.4301 = ASTM 304) is used, which stands out through its high stability, optimal hygienic properties and corrosion-resistance towards many (but not all!) chemical compounds (caution for example with chlorine compounds).

The chamber load for the appliance must be carefully checked with respect to chemical compatibility with the materials mentioned.

A resistance table for all these materials can be requested from the company MEMMERT.

2.6 Intended Use

CTC temperature test chambers and CTC climatic test chambers may be used exclusively for temperature and climate testing of materials and substances in the context of the procedures and specifications described in this manual. Any other use is improper, and may result in hazards and damage.

The test chambers are not explosion-proof (they do not comply with the workplace health & safety regulation VBG 24 of the Administrative Employers' Liability Insurance Association). The chambers may only be loaded with materials and substances which cannot produce any toxic or explosive vapours at temperature ranges up to 190 °C , and which themselves cannot explode, burst or ignite.

The test chambers may not be used for drying, vaporising and branding paints or similar materials, the solvents of which could form an explosive mixture when combined with air. If there is any doubt as to the composition of materials, they must not be loaded into the test chamber. Potentially explosive gas-air mixtures must not be produced, either in the interior of the chamber or in the direct vicinity of the appliance.

2.7 EC Declaration of Conformity



memmert

EC Declaration of Conformity

Manufacturer's name and address:

MEMMERT GmbH + Co. KG
 Äußere Rittersbacher Straße 38
 91126 Schwabach, Germany

Product:

limatic Testing Chambers

Type:

CTC.../ TTC

Size:

256

Rated voltage:

AC 400 V 50 Hz

This product complies with the provisions of the directives:

Machinery Directive 2006/42/EC
 and revisions

Directive of the Council for harmonisation of the laws of Member States on the level of protection for accident prevention.

The tested product's level of compliance with the essential protection requirements of the Directive is substantiated by its compliance with the following standards:

EN ICO 12100-1, -2: 2004
 EN ISO 13850: 2007

EN ISO 13857: 2008
 EN 60204-1: 2007

EMC Directive 2004/108/EC
 and revisions

Directive of the Council for harmonisation of the laws of Member States on electromagnetic compatibility.

The tested product's level of compliance with the essential protection requirements of the Directive is substantiated by its compliance with the following standards:

DIN EN 61326-1: 2006-10
 DIN EN 61000-3-11: 2001-04

EN 61326-1: 2006
 EN 61000-3-11: 2000

Applied harmonised standards:

Low Voltage Directive 2006/95/EC
 and revisions

Directive of the Council for harmonisation of the laws of Member States relating to electrical equipment designed for use within certain voltage limits.

The tested product's level of compliance with the essential protection requirements of the Directive is substantiated by its compliance with the following standards:

DIN EN 61 010-1 (VDE 0411 part 1):2002-08
 DIN EN 61 010-2-010 (VDE 0411 part 2-010):2004-06

EN 61 010-1:2001
 EN 61 010-2-010:2003

Schwabach, Germany, 12.10.12

(legally binding signature of the manufacturer)

This declaration states the compliance with the above Directives, however, does not provide any warranted properties. The safety instructions in the supplied documents have to be observed.

D24897

2.8 Designation (nameplate)

The nameplate provides information about the appliance model, manufacturer and technical data. It is attached to the front of the appliance, on the right beneath the interior (see page 10).

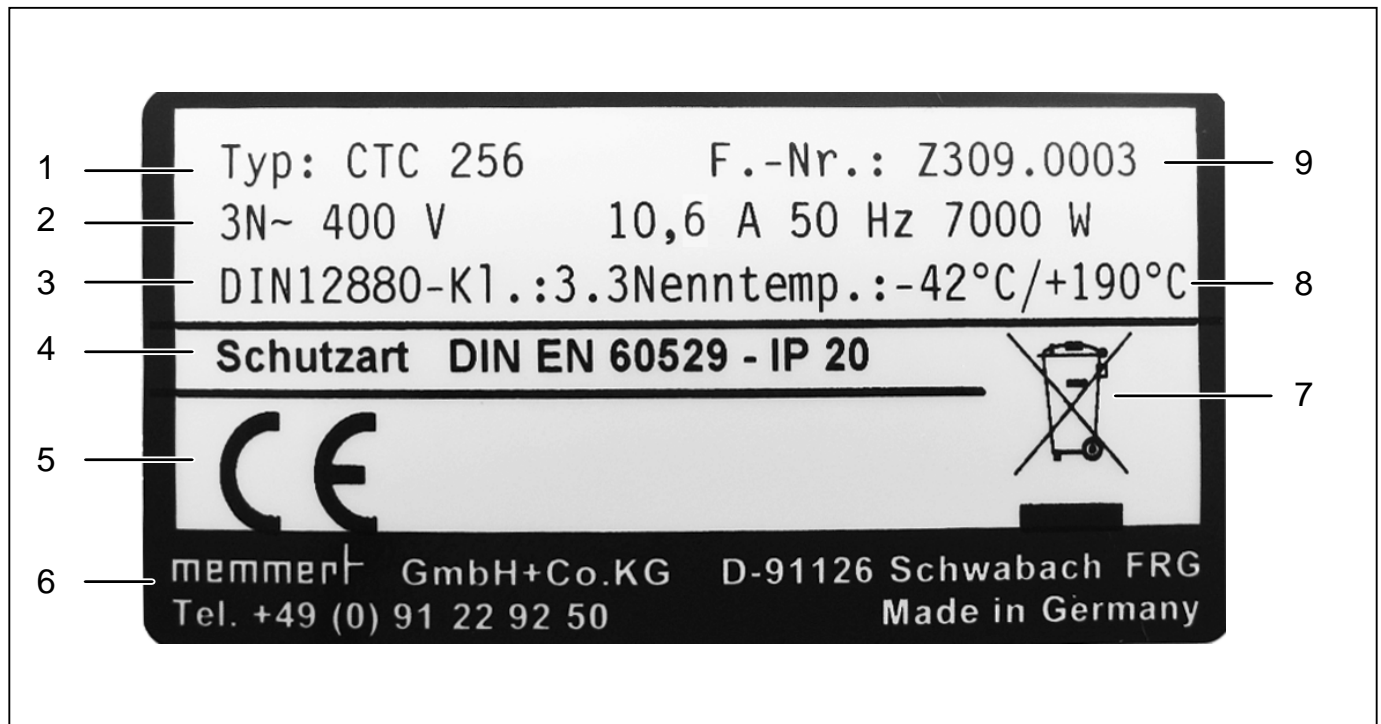

Fig. 8 Nameplate

- 1 Type designation
- 2 Connected loads
- 3 Applied standard
- 4 Degree of protection
- 5 CE conformity
- 6 Manufacturer address
- 7 Disposal note
- 8 Rated temperature range
- 9 Factory number

2.9 Technical data

Type	TTC 256	CTC 256
Chamber width A* [mm]	640	
Chamber height B* [mm]	670	
Chamber depth C* [mm]	597	
Appliance width D* [mm]	898	
Appliance depth F* [mm]	1100	
Appliance height E* [mm]	1730	
Chamber volume [liter]	256	
Weight [kg]	≤ 320	≤ 350
Performance [W]	7000	
max. number of sliding grates	6	
max. load per sliding grate [kg]	25	
max. load per appliance [kg]	100	
Temperatures min/max.	-42 °C/+190 °C	
Adjustment precision	-42 °C – 100 °C: 0,1 °C 100 °C – 190 °C: 0,5 °C	
Monitoring	-50 °C ... +200 °C	
Humidity	–	10–98 % rh
Refrigerant used	Type	R449A
	GWP	1397
	Filling weight	1.8 kg
	CO ₂ equivalent	2.51 t
Noise level	≤ 62 dBA	
Air circulation in chamber	≤ 1200 m ³ /h	
Electrical equipment		
Operating voltage	3N~ 400 V	
Current consumption	10,6 A	
Safety class	1 (acc. to EN 61010)	
Degree of protection	IP 20 (EN 60529)	
Interference-suppressed	class B acc. to EN 55011	
Fuses	250 V/F 15 A	

* See Fig. 9 on page 18.

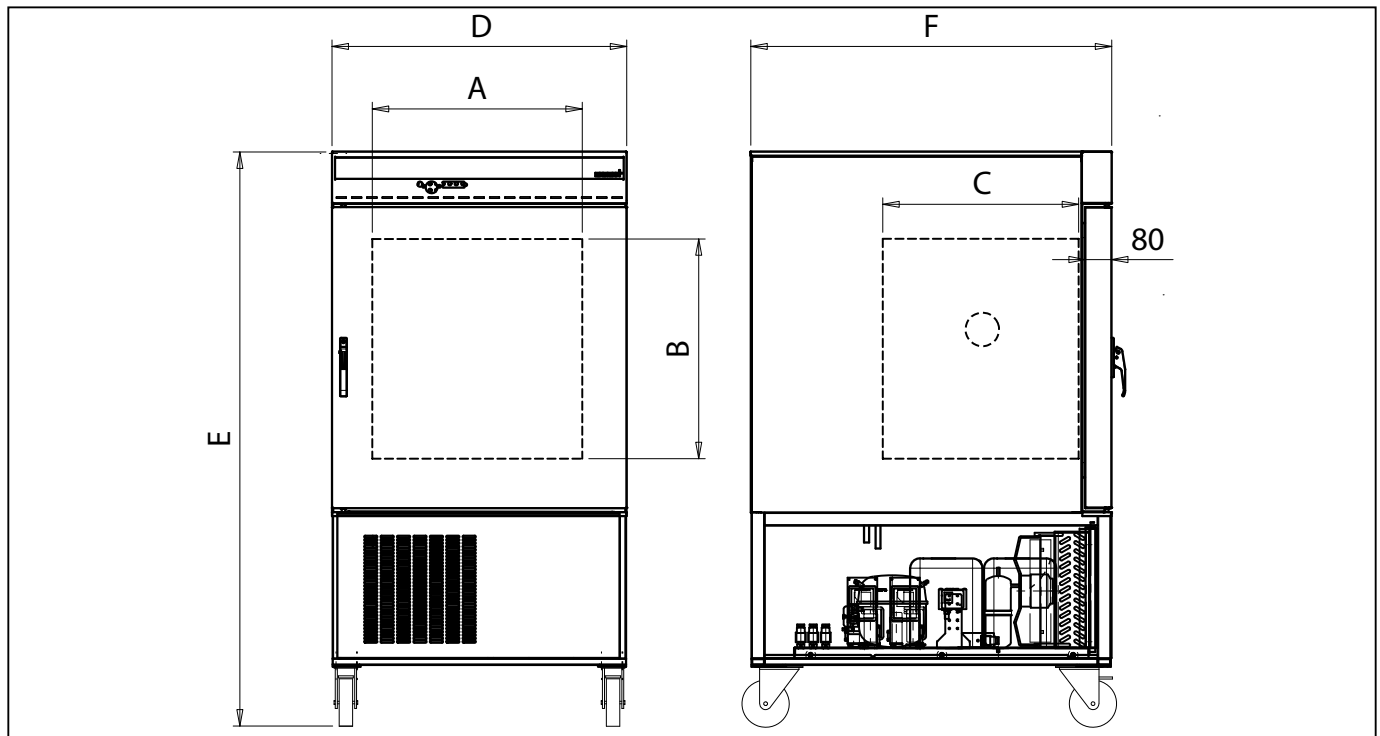

Fig. 9 Dimensions of CTC/TTC test chambers

2.10 Environmental conditions

- ▶ The test chamber may only be used in enclosed rooms and under the following environmental conditions:

Ambient temperature:	16 °C to 28 °C
Air humidity:	max. 70 % not condensing degree of pollution: 2
Altitude of installation	max. 2000 m above sea level

- ▶ The test chamber may not be used in areas where there is a risk of explosions. The ambient air must not contain any explosive dusts, gases, vapours or gas-air mixtures. The test chamber is not explosion-proof.
- ▶ Heavy dust production or aggressive vapours in the vicinity of the appliance could lead to sedimentation in the chamber interior and as a consequence, could result in short circuits or damage to electrical parts. For this reason, sufficient measures should be taken to prevent large clouds of dust or aggressive vapours from developing.

2.11 Connections

Observe the country-specific regulations when making connections (e.g. in Germany DIN VDE 0100 with RCD circuit breaker).

This appliance is intended for operation on an electrical power system with a system impedance Z_{\max} at the point of transfer (service line) of a maximum of 0.292 Ohm. The operator must ensure that the test chamber is operated only on an electrical power system that meets these requirements. If necessary, you can ask your local energy supply company what the system impedance is.

2.12 Standard accessories

- ▶ Steel grids
- ▶ Silicone plugs to close up the cable feed-through in the right-hand side wall (see Fig. 17 on page 26)

3. Delivery, Transport and Setting Up

3.1 Safety Regulations

**Warning!**

You may get your hands or feet squashed when transporting and installing the test chamber. Wear protective gloves and work shoes.

**Warning!**

Because of the weight of the chamber, you could get injured if you try to lift it. Transport the test chamber only with a fork-lift truck, manual pallet jack or on its castors. The transport means used must be designed to carry the weight of the test rig (see chapter 2.9 Technical data on page 17). The test chamber may only be moved using a means of transport by persons who have the required qualification for this (e.g. fork-lift licence).

The test rig may not be transported with a crane.

**Warning!**

The test chamber could fall over and seriously injure you. Never tilt the test chamber and transport it only in an upright position. This will also prevent oil from running out of the cooling unit and into the refrigerant circuit. The weight of the test chamber is divided asymmetrically, since the refrigeration unit is located on the left side.

3.2 Delivery

The test chamber can be packaged in a cardboard or other box, and is delivered on a wooden pallet.

3.2.1 Unpacking

Remove cardboard packaging by pulling upwards or cutting carefully along an edge. Unscrew wooden crate and remove. Raise climate chamber from the wooden pallet using a fork-lift truck or manual pallet jack and set down on the castors of the appliance.

3.2.2 Checking for completeness and transport damage

- ▶ Check the delivery note to ensure that the delivery is complete.
- ▶ Check the test chamber for damage, fluid leaking, etc.

If you notice deviations from the delivery note, damage or irregularities, do not put the test chamber into operation, but inform the haulage company and the manufacturer.

3.2.3 Disposing of packaging material

Dispose of the packaging material (cardboard, wood) in accordance with the appropriate regulations for the material in your country.

3.3 Storage after delivery

If the test chamber is first to be stored after delivery: Read the storage conditions from page 65.

3.4 Transport

The test chamber can be transported in three ways:

- ▶ on its own castors, for which the catch on the (front) castors must be released
- ▶ with a fork-lift truck; move the forks of the truck entirely under the test chamber
- ▶ on a manual pallet jack

i Caution: If the test chamber is to be transported again after it has been put into operation, for example at a different location: First empty the freshwater and condensation water tanks (see page 22).

3.5 Installation



Warning! Never stack test chambers on top of each other. The test rig on top could fall down and serious injury or death could occur.



Warning! The test chamber may only be installed on the floor, and never on tables or similar. A table could collapse, or it could fall off and serious injury or death could occur.

The installation site must be flat and must be able to reliably carry the weight of the test chamber (see chapter 2.9 Technical data on page 17).

An 400 V/16 A/50 Hz power connection (CEE socket) must be available at the installation site.

The distance between the test chamber and the walls/ceiling must be at least 25 cm. The ventilation slits of the cooling unit on the front of the appliance (see page 10) may not be manipulated.

Sufficient air circulation in the vicinity of the chamber must be guaranteed at all times.



Abb. 10 Minimum clearance from walls and ceiling

Position the test chamber exactly level.

After installing, lock the front swivel castors.

4. Putting into Operation

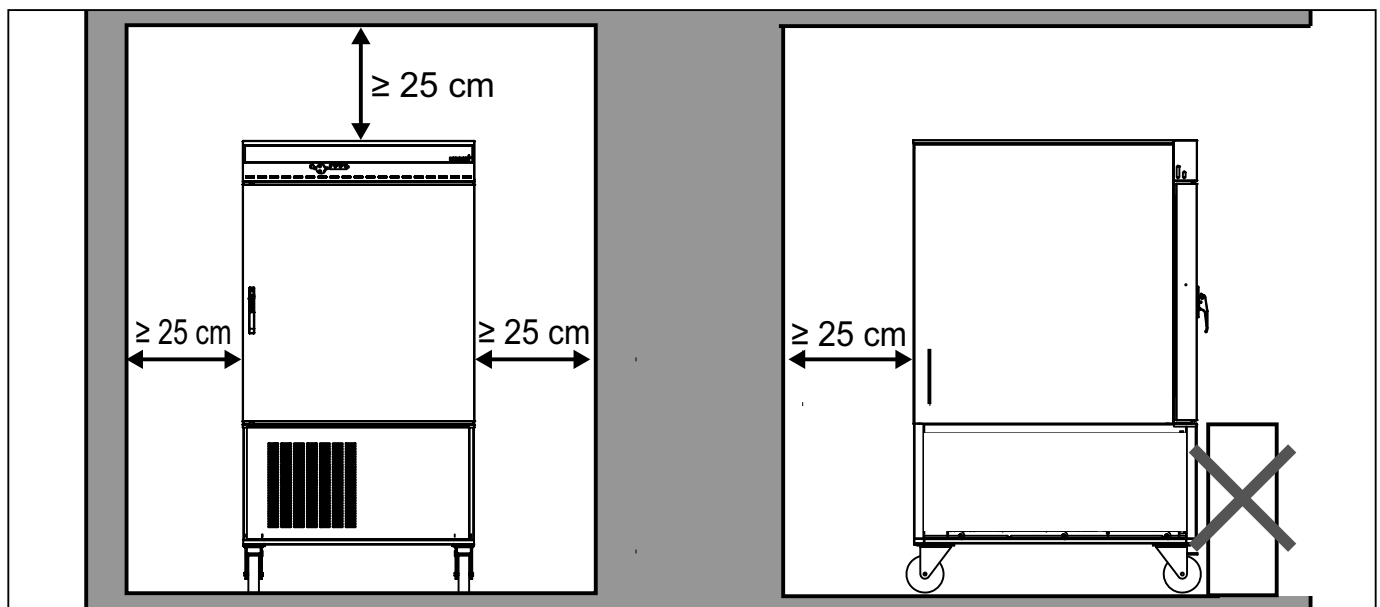
i Caution: The test chamber may not be put into operation before 24 hours after installation at the point of operation, so that any oil that may have penetrated the tubing can flow back into the compressor of the cooling unit and return to room temperature.

4.1 Checking the door and adjusting if necessary

A well-closing door is indispensable for temperature and climatic test chambers. The door may have been twisted during transport. You should therefore check whether the door closes properly and the seals are in the correct position. Adjust door if necessary (description on page 63).

4.2 Checking the temperature sensors

Especially strong vibrations during transport could result in the temperature sensors being moved in their holders in the working chamber. Before operating for the first time, check the temperature sensors for their correct positioning and, if necessary, adjust their position in the holder (Fig. 11).

Open the door to do this (see page 25)

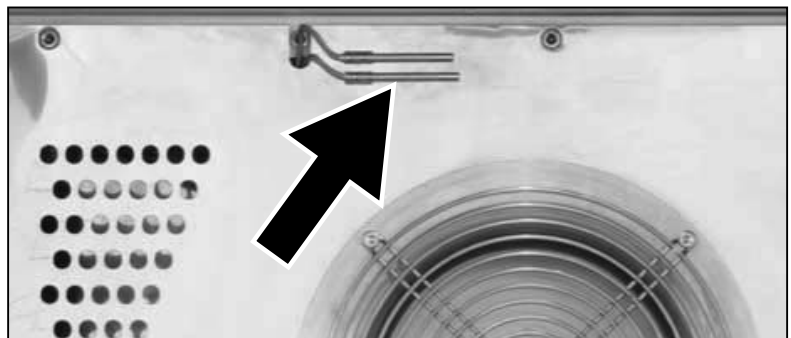

Fig. 11 Checking the temperature sensors and adjusting if necessary

4.3 Install and connect laptop (optional)

The test chamber can be optionally fitted with a laptop, which can be used to programme and control it. The laptop is pre-mounted on a holder.

To assemble, screw down the laptop holder with the two enclosed M5 screws in the bore holes on the left of the test chamber (Fig. 12, see also page 10). Connect the USB and mains cables on the side at the bottom of the chamber (see page 11, Fig. 4).

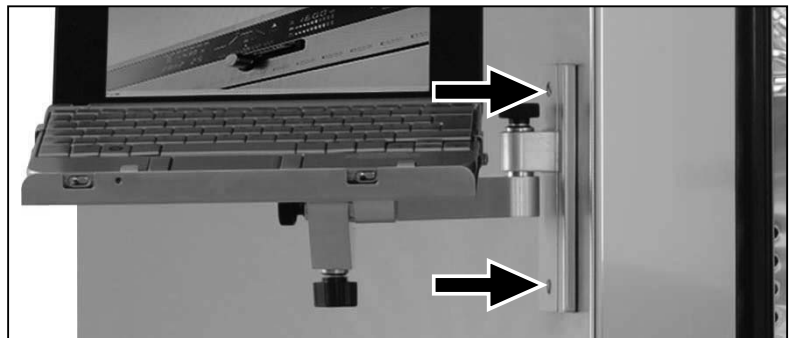

Fig. 12 Attaching the pre-mounted laptop holder with two screws to the test chamber

4.4 Filling the freshwater tanks

(only for CTC 256 climatic test chambers)

Water specifications

Only demineralised/deionised water with the following specifications may be used in Memmert appliances:

- ▶ Conductivity of 5 – 10 $\mu\text{S}/\text{cm}$
- ▶ pH value between 5 and 7
- ▶ chlorine-free

The use of ultrapure water or DI water with an electrical conductance level below 5 $\mu\text{S}/\text{cm}$ can damage silicone tubing and cause pitting on the stainless steel components installed. Unsuitable water also creates favourable conditions for limescale in the steam generators and steam pipes.

The CTC climatic test chamber is equipped with four tanks, each holding 10 litres; these are located in the drawer at the front right (Fig. 13). The two rear tanks (A1 and A2) are used to collect condensation water produced during operation. The two front tanks (B1 and B2) contain fresh water, which the test chamber needs to humidify the interior. The TTC temperature test chamber is equipped with just two condensation water tanks, and has no fresh water tank.

To fill the fresh water tank, pull the drawer out of the test chamber (Fig. 13). Press the attachment clip on the tube connection and pull the tube connection upwards and off (Fig. 14). The lid can be removed, the tank taken out and filled with fresh water. Then, twist the lid back onto the tank and push on the tube connection until it clicks into place.

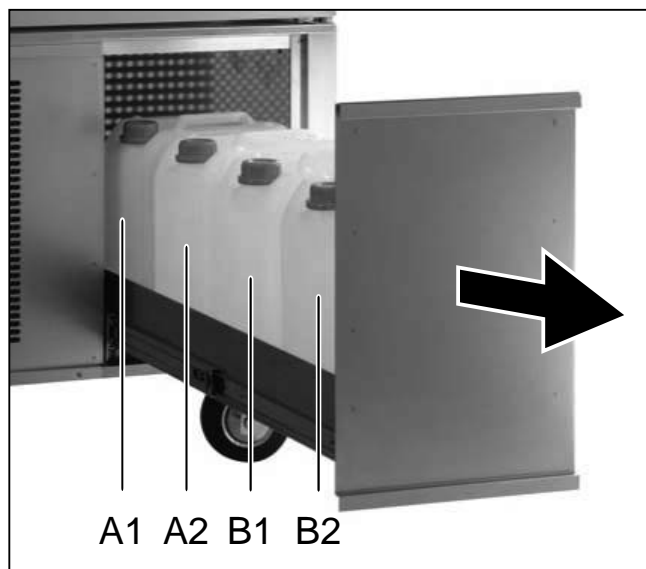

Fig. 13
 Tank drawer (shown in figure: CTC climatic test chamber, the TTC temperature test chamber has just one condensation water tank behind a flap, and no freshwater tank)
 A1, A2 2 condensation water tanks, 10 l each
 B1, B2 2 freshwater tanks, 10 l each

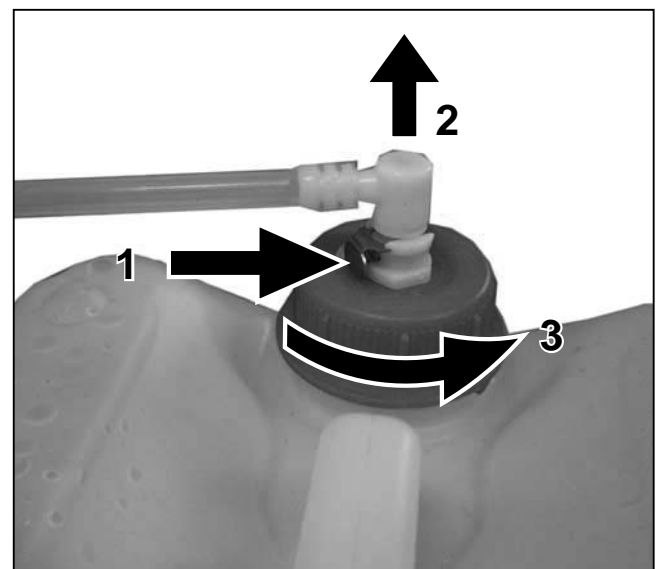

Fig. 14
 1 Press the attachment clip on the tube connection
 2 Pull the tube connection upwards and off.
 3 Open the sealable lid

4.5 Connecting

- i Caution:** Observe the country-specific regulations when making connections (e.g. in Germany DIN VDE 0100 with an RCD circuit breaker). Also observe the connected loads and power values (see chapter 2.9 Technical data on page 17).

The test chamber is intended for operation on an electrical power system with a system impedance Z_{\max} at the point of transfer (service line) of a maximum of 0.292 Ohm. The operator must ensure that the test chamber is operated only on an electrical power system that meets these requirements. If necessary, you can ask your local energy supply company what the system impedance is.

Only appliances may be connected to external connections whose interfaces comply with the requirements for safety extra-low voltage (e.g. computer, printer).

- Switch on appliance by pressing the main switch on the front of the appliance (see Fig. 19 on page 27).

- i Caution:** The first time the appliance is operated, it must not be left unattended until it has reached the steady state.

5. Operation and control

5.1 Operating staff

The test chamber may only be operated by persons who are of legal age, and who have received instructions for the test chamber. Personnel who are to be instructed or who are undergoing general training may only work with the test chamber under the continuous supervision of an experienced person.

5.2 General information on operation

The condensation pressure of the cooling unit is controlled by the automatic speed adjustment of the condenser fan. The fan can therefore automatically run faster or slower in operation, depending on the thermal energy extracted. The speed of the interior fan can also vary: At low temperatures the fan speed is automatically reduced. In strong heating operation it is automatically increased.

5.3 Before starting

1. Empty the condensation water tank. To do so, pull out the tank drawer from the test chamber (for CTC climatic test chambers, see Fig. 15) or open the flap (for TTC temperature test chambers).
2. Screw open the lids of the condensation water tanks A1 and A2, remove tanks, empty and then re-insert them and screw the lids back on.

- i Caution:** Do not mix up the lids, otherwise condensation water may leak. Screw on the lid with the T-connector onto the tank at the rear (A1) (Fig. 15), so that condensation water can flow into tank A2 when tank A1 is full.
3. For the climatic test chambers CTC, fill the two fresh water tanks (B1 and B2) as described on page 22.
 4. Check whether the silicone plugs have been inserted into the feed-through on the right side of the appliance and if the seal is tight (see Fig. 17 on page 26).

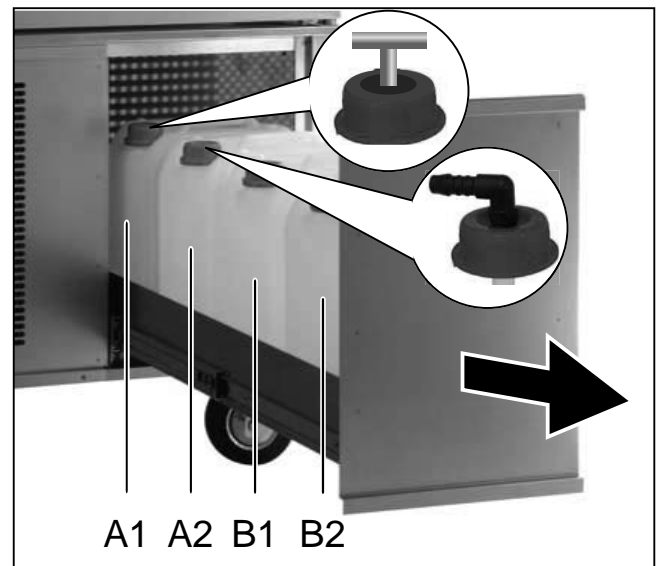

*Fig. 15 Tank drawer (shown in figure: CTC climatic test chamber, the TTC temperature test chamber has just one condensation water tank behind a flap, and no freshwater tank)
A1, A2 2 condensation water tanks, 10 l each
B1, B2 2 freshwater tanks, 10 l each*

5.4 Opening and closing the door



Danger!

When opening the chamber door, hot steam may escape and scald you in the face if the test chamber was in operation directly before this. Remain behind the door when you open it and let out the steam, or allow the test chamber to cool down before opening the door.



Warning!

Depending on operation, the surfaces in the chamber interior, the viewing window and the chamber load may be very hot or very cold. You could suffer from burns or frostbite if you touch these surfaces.



Allow the chamber interior to first adjust to room temperature after opening the door, or use heat-resistant protective gloves.



*Fig. 16
Opening and closing the door*

- ▶ To open the door, pull the handle upwards and swing the door open (Fig. 16).
- ▶ To close the door, press the handle downwards.

5.4.1 Opening and closing the door with high and low temperatures

The airtight construction of the climate chamber leads to physical effects when opening and closing the doors, due to the temperature-dependent volume change of the enclosed air.

At high temperatures, excess pressure is produced in the chamber, since the ambient air introduced heats up and expands. Do not close the doors with force in this case, but wait a few seconds before closing, so that the excess pressure can dissipate. To do this, press the door lightly, wait until the excess pressure has dropped, and only then close the door properly.

At low temperatures, a vacuum is created in the chamber after the doors have been closed. As long as the pressure is not compensated, it is difficult to open the doors. In this case you should wait for two minutes until the pressure is compensated.

The pressure compensation can be accelerated considerably by removing the silicone plugs (Fig. 17 on page 26).

5.5 Loading the test chamber



Warning!

When loading the chamber with an unsuitable load, toxic or explosive vapours or gases may be produced. This could cause the chamber to explode, and people could be badly injured or poisoned. The chamber may only be loaded with materials/test objects which do not form any toxic or explosive vapours when heated up and cannot ignite (see also chapter 2.6 Intended Use on page 14). If there is any doubt as to the composition of materials, they must not be loaded into the test chamber.



i Caution:

Check the chamber load for chemical compatibility with the materials of the test chamber (see page 14).

When operating the chamber with a chamber load which itself emits heat to the interior, disable the automatic defrosting system (see page 54 and chapter 7.2 Basic appliance settings (Setup) on page 46).

Insert sliding grate(s). (One sliding grate is included in the standard delivery.)

The chamber must not be loaded too tightly, so that proper air circulation in the working chamber is guaranteed. Do not place any of the chamber load on the floor, touching the side walls or right below the ceiling of the working chamber.

The maximum number and load capacity of the sliding shelves can be found in the table in chapter 2.9 Technical data on page 17. If the load is set up unfavourably (too close together) it may take longer than normal to reach the set temperature under certain circumstances.

For test samples which require wires during the test (for power supply or for measuring purposes), the test chamber is equipped with a cable feed-through on the right-hand side (Fig. 17, see also page 10).

Pull out the silicone plugs if they are plugged in (Fig. 17), and push the wires into the interior of the chamber. Then re-insert the plugs and press them tight, so that no heat/humidity can escape from inside the chamber through the feed-through.

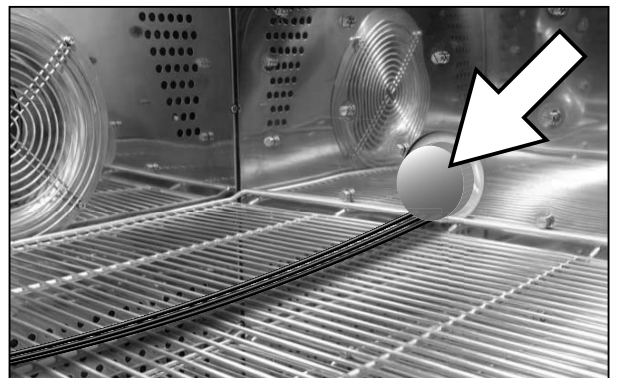

Fig. 17 Cable feed-through with plugs in the right-hand side of the appliance

5.6 Basic operating information

5.6.1 Switching appliance on and off

The test chamber is switched on and off by pressing the main switch/push-turn control on the front of the appliance.

- ▶ Switching on: press the main switch so that it comes out of the appliance (Fig. 18).
- ▶ Switching off: press the main switch so that it retracts back into the appliance (Fig. 19).

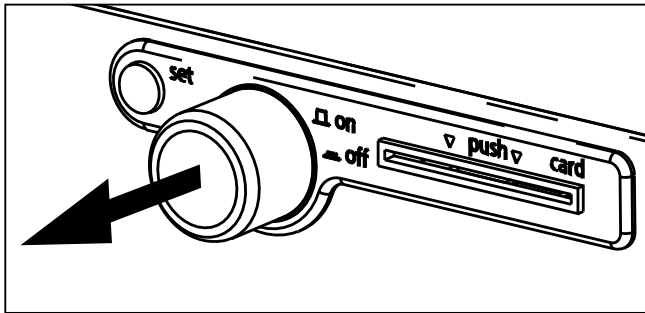

Fig. 18
Switching on test chamber

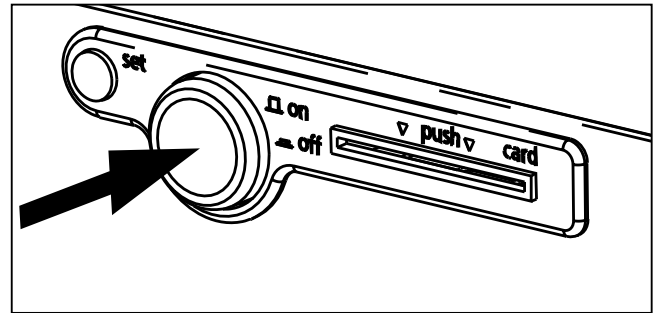

Fig. 19
Switching off test chamber

i For safety reasons, the cooling system may still run for up to two minutes after being switched off, to set itself to a safe state.

5.6.2 Operating panel/ controller

In normal and programme modes the desired parameters are entered on the operating panel of the controller on the front of the appliance (Fig. 20). Basic settings, as well as those for time and printing, can also be made here. In addition, programmed and current parameters are displayed, as well as warning messages:

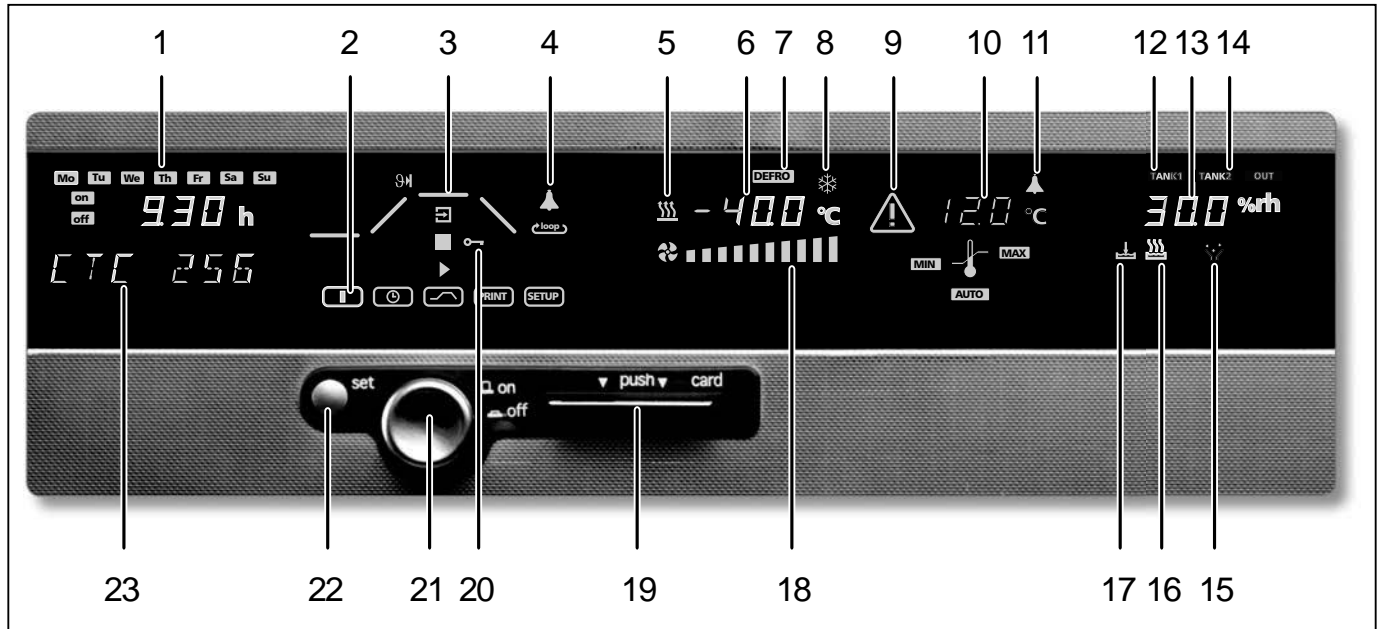
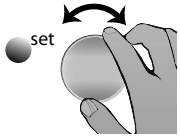

Fig. 20 Operating panel (in the example, the CTC climatic test chamber is shown)

- 1 Time display
- 2 Operating mode display (see Fig. 21 on page 30)
- 3 Programme mode display (see page 35)
- 4 Horn sound for programme end
- 5 Display: appliance is heating up
- 6 Temperature display
- 7 Automatic defrosting system active (see page 54)
- 8 Display: appliance is cooling down
- 9 Temperature monitoring warning (see page 48)
- 10 Temperature monitoring (see page 48)
- 11 Acoustic temperature monitoring alarm icon (see page 48)
- 12 Water tank 1 active (only for CTC 256)
- 13 Humidity display (only for CTC 256)
- 14 Water tank 2 active (only for CTC 256)
- 15 Display: appliance dehumidified (only for CTC 256)
- 16 Display: steaming process (only for CTC 256)
- 17 Warning water tank empty (only for CTC 256, see page 22)
- 18 Fan speed
- 19 Chip card reader (see page 58)
- 20 Display: appliance locked with user-ID card (see page 60)
- 21 Main switch / push-turn control
- 22 Set key
- 23 Alphanumeric text display for error and status messages

5.6.3 Basic operation



All operating functions are selected by turning the push-turn control to the left or right ...

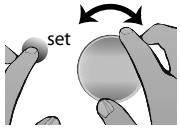

... .. and adjusted by turning it with the SET key held down.

5.6.4 Setting parameters

Normally, all setting actions on the operating panel described on the following pages are made in the same way:

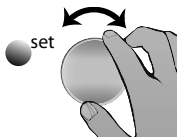

1. Select the desired parameter with the push-turn control (menu item, e.g. temperature), then all other parameters go dark and the selected one flashes.

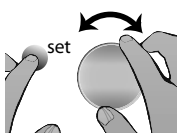

2. With the SET key held down, set the desired value (e.g. 58.0 °C) with the push-turn control.

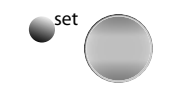

3. 3. Release the SET key, and the set value is saved. The display briefly shows the set value, flashing. Then the current temperature is displayed and the test chamber begins to heat up or cool down to the set temperature.

4. Settings for other parameters are made in the same way.

i The control returns automatically to the main menu if the push-turn control or SET key is not operated for approx. 30 seconds.

5.7 Operating modes

TTC temperature test chambers and CTC climatic test chambers can be operated in four different modes:

- ▶ Normal mode: The test chamber runs in permanent operation at the temperature, humidity and fan values set on the operating panel. Operation in this mode is described from page 30.
- ▶ Week time switch: The test chamber runs at the set values only at certain times. Operation in this mode is described from page 33.
- ▶ Programme mode: Time sequences of temperature, humidity (only with CTC 256) and fan values are programmed (so-called ramps), which the test chamber automatically works through one after another. Operation in this mode is described from page 35.
- ▶ Interface mode with PC/laptop (optional, see page 43).

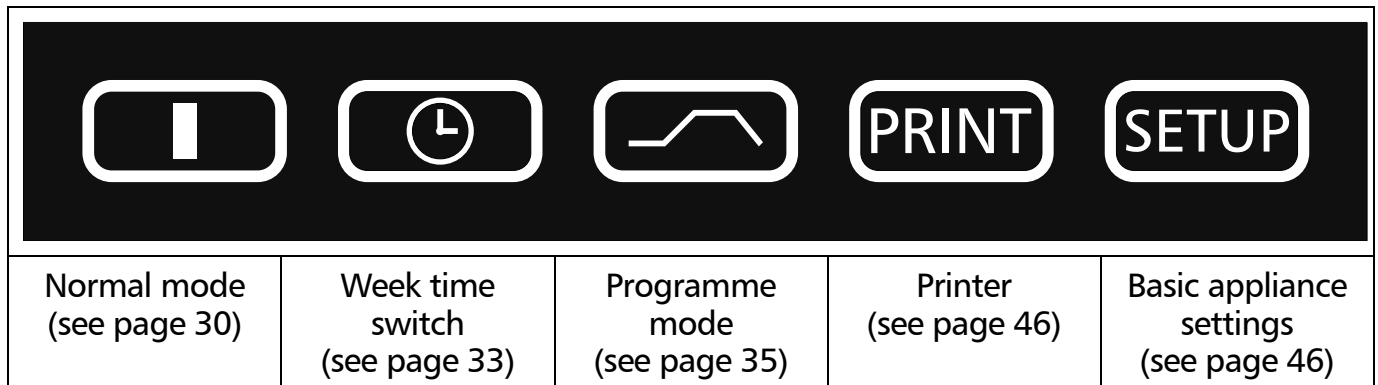

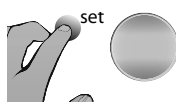
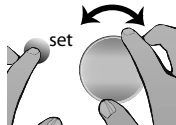



Fig. 21 Operating modes

5.8 Operating mode - settings

- 

1. Switch on appliance by pressing the main switch (main switch comes out of appliance, see Fig. 18).
- 

2. Hold SET key down for approx. three seconds, the selected operating mode then begins to flash.
- 

3. Select the desired operating mode (normal mode, week time switch, programming mode, printer or basic appliance settings) by turning the control with SET key held down.
- 

4. Release the SET key, and the selected operating mode is saved.

5.8.1 Normal mode

The test chamber runs in permanent operation in this operating mode, at the values set on the operating panel (see above). Example of settings: see next Chapter 5.8.2.

- Load test chamber (see page 26).
- Switch on appliance by pressing the push-turn control on the operating panel so that it comes out of the appliance (Fig. 18).
- Select the normal operating mode  with the push-turn control:



- As described above, set the individual parameters with the push-turn control and the SET-key:

Temperature setpoint

Adjustment range: - 42°C to 190°C



Fan speed

Adjustment range: 10 % to 100 % in 10-% steps



- i** At low temperatures the fan speed is automatically reduced. In strong heating operation it is automatically increased.

Temperature monitoring

Adjustment range::
MIN MAX AUTO
(see also page 48)

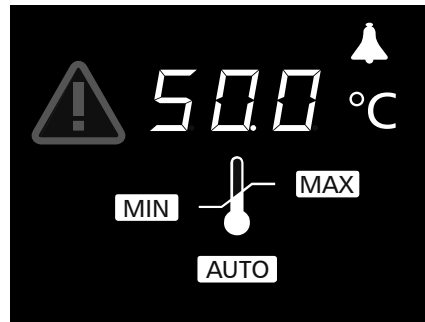

Humidity setpoint
(only for CTC 256)

Adjustment range:
10 to 98 %rh, off



i Not all combinations of temperature and humidity are possible (see also Fig. 5 on page 12).

5.8.2 Example setting Normal mode

The test chamber should heat up to 50 °C with a humidity of 70 % rh and a fan speed of 40 %. The monitoring function MAX should respond at 55 °C and MIN at 45 °C:

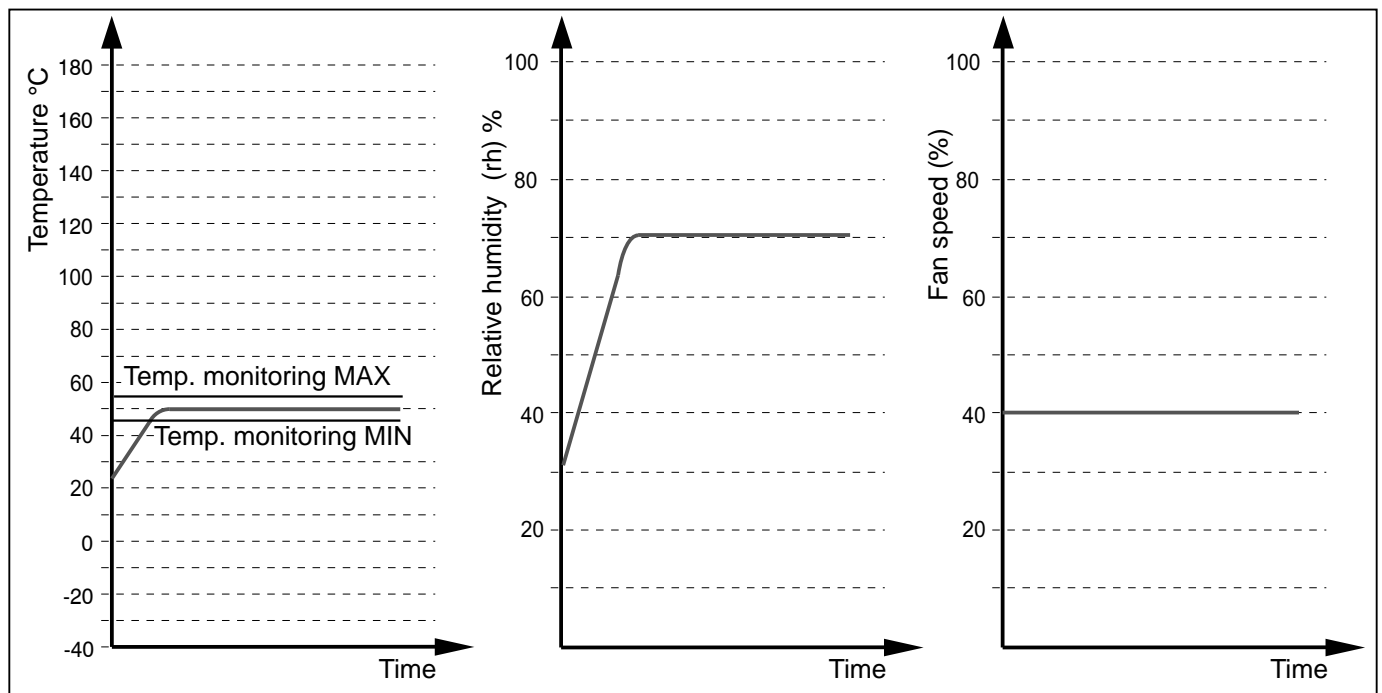



Fig. 22 Example of normal mode (only for CTC 256)

1. Setting the normal operating mode:

Hold SET key down for approx. 3 seconds, the current operating mode then begins to flash.

Select the operating mode  with the push-turn control, while the SET key is held down. After you let go of the SET key, the control is in the normal operating mode.





2. Setting the temperature setpoint:

Hold down the SET key and set the desired temperature setpoint of 50.0 °C.



Release the SET key, the appliance will briefly flash, showing the temperature setpoint. Then the current temperature appears on the display and the controller begins to move to the set temperature of 50.0 °C.

- ▶ Heating up is indicated by the  symbol
- ▶ Cooling down is indicated by the green cooling symbol 

3. Setting the fan speed:

Turn the push-turn control to the right until the fan display flashes.

With the SET key held down, set the fan speed to 40 % with the push-turn control (four bars light up).

Release the SET key. The fan is now running at 40 %.



4. Setting the monitoring temperature:

Turn the push-turn control to the right until the monitoring temperature and the MIN or MAX icon flashes. Hold down the SET key and with the push-turn control set the overtemperature limit to 55.0 °C and the undertemperature limit to 45.0 °C. Turn the push/turn control to the right until the monitoring temperature and the AUTO icon flash. Hold down the SET key and make your setting with the push-turn control.



 The tolerance band is set in the SETUP menu (see Chapter 7.2).

5. Setting the humidity setpoint (only for CTC 256)

Turn the push-turn control to the right until the humidity display flashes. Hold down the SET key and set the desired humidity setpoint of 70.0 % rh with the push-turn control.

After releasing the SET key the humidity setpoint briefly flashes. Then the current humidity value appears on the display and the controller begins to move to the set value.

The humidification process is indicated by the  symbol. The test chamber is now running in permanent operation with the set values.



5.8.3 Week time switch

In this operating mode, the week time switch is active and the test chamber switches on and off at the time programmed.



During the OFF phase of the week time switch, the test chamber is in standby mode.

The heating and cooling functions are switched off here and the controller display shows the time, dimmed. During the ON phase, the test chamber works with the set values for temperature, humidity, etc.

The sequence of the week time switch repeats itself each week.

In total a maximum of nine time blocks can be programmed, consisting of the switching on and switching off times:



By turning the push-turn control, the following parameters can be selected and altered, as described in in chapter 5.6.3 Basic operation on page 29:

Weekday

Adjustment range: Monday to Sunday



Day groups

Adjustment range: Working days Mo-Fr
Weekend Sat-Sun

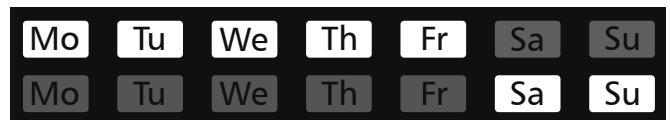

No switch-on time: ----

Appliance not switched on on this day



Switch-on time (on)

Adjustment range: 00:00 to 23:59



Switch-off time (off)

One minute beyond the switch-on time to 24:00



By turning further to the right, parameters (temperature setpoint etc.) can be selected as in the normal operating mode.

If no settings (temperature setpoint etc.) are made for the ON phase, the controller uses the values from the normal operating mode .

For reasons of safety, you should always check that only one switch-on time is programmed in the desired time blocks and days.

Direct setting of the temperature setpoint:

If the controller is in standby mode or the week time switch is in the ON phase, the temperature setpoint can be directly accessed by briefly pressing the SET key. By turning the control to the right, you are returned to temperature monitoring and humidity. By turning to the left you come back to the settings for the individual time blocks.

5.8.4 Example of settings Week time switch

The test chamber should be switched on at 07:30 from Mo–Fr (working day group) and switched off at 18:00, and in addition it should operate on Saturdays from 10:00–14:00 (Fig. 23).

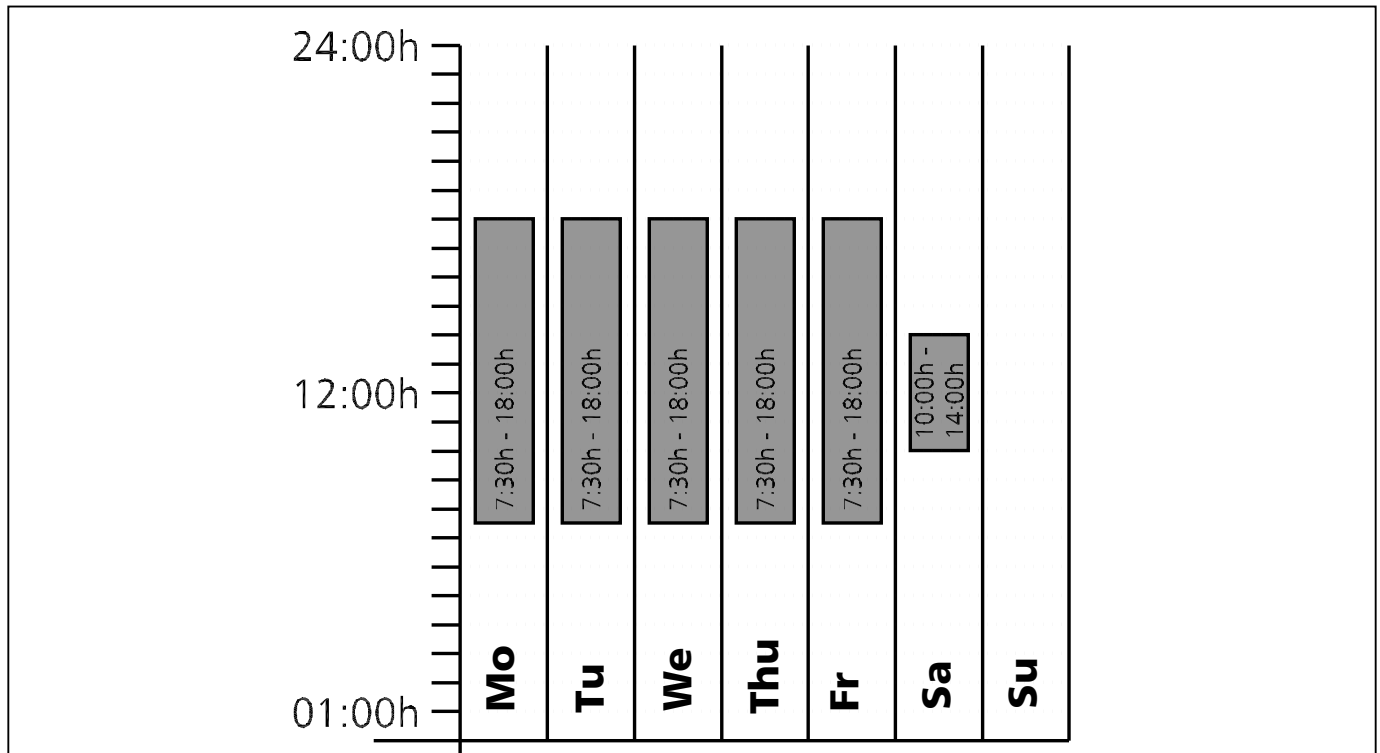

Fig. 23 Operation with week time switch (example)

1. Setting the week time switch operating mode

Hold the SET key down for approx. 3 seconds; the current operating mode then begins to flash. Select the week time switch operating mode with the push-turn control, while the SET key is held down.

Release the SET key; the control is now in the week time switch operating mode.

2. Switch on Mo-Fr at 7:30

Turning the push-turn control to the left, select "Mo-Fr on" (group working days).

Hold down the SET key and set the desired switch-on time to 7:30 with the push-turn control.

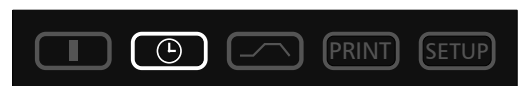

3. Switch off Mo-Fr at 18:00

Select "Mo-Fr off" (group working days) with the push-turn control.

Hold down the SET key and set the desired switch-off time to 18:00 with the push-turn control.

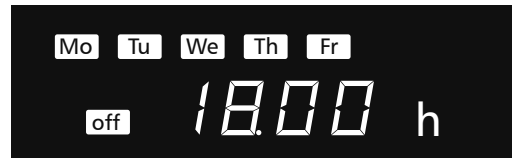

4. Switch on Sa at 10:00

Select "Sa on" with the push-turn control.

Hold down the SET key and set the desired switch-on time to 10:00 AM with the push-turn control.

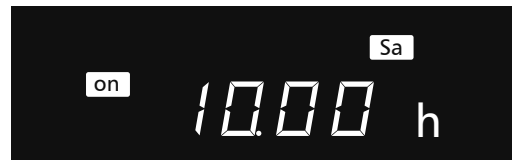

5. Switch off Sa at 14:00

Select "Sa off" with the push-turn control.

Hold down the SET key and set the desired switch-off time to 02:00 PM with the push-turn control.

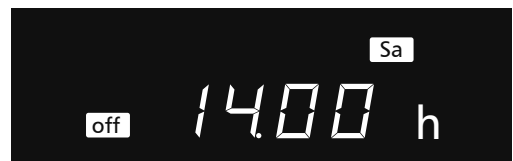

5.8.5 Programming mode

In this operating mode up to 40 freely programmable sequences (ramps) can be set with various combinations of temperature, fan speed and humidity (humidity only for the CTC 256), which the test chamber then processes automatically one after another.



i Not all combinations of temperature and humidity are possible (see also Fig. 5 on page 12).

Setting the Programming operating mode

1. Press the SET key and keep it held down.
2. Select the programming mode with the push-turn control, while the SET key is held down.
3. Select the EDIT function  with the push-turn control.



You can now select and modify the following parameters in turn (see also the adjustment example on page 39):

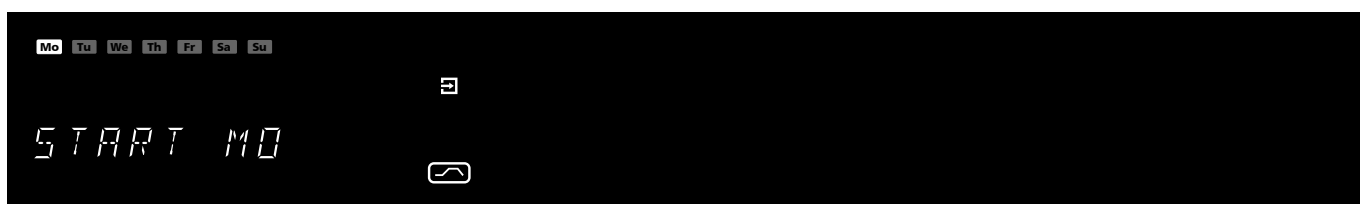

4. Delayed programme start: Switch-on day

Adjustment range: Monday to Sunday, workdays Mo-Fr, weekends Sa-Sun, every day Mon-Sun or no days. If no week day is set, the appliance starts immediately (INSTANT START) after the start of the programme.

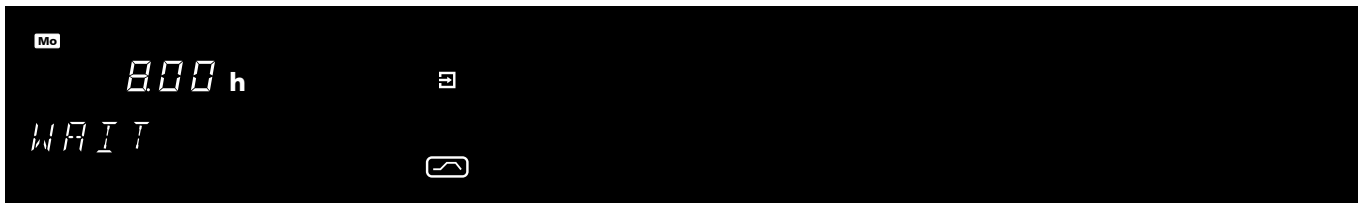

5. Delayed programme start: Switch-on time

Adjustment range: 00.00 to 23.59 (shown in picture: Switch-on time 8:00)

i If no switch-on day is selected, then no switch-on time can be selected, and the programme starts immediately (INSTANT START).



6. Duration of first ramp segment

Adjustment range: 1 minute to 999 hours (shown in picture: duration 1.00 hour)

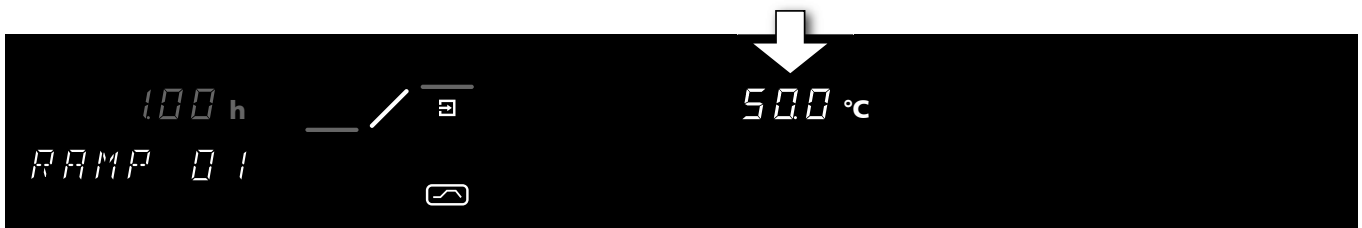

7. Setpoint temperature/temperature to end of ramp segment

Adjustment range - 42 °C ... 190 °C (shown in picture: Temperature 50 °C)



8. Fan speed in ramp segment

Adjustment range: 10 % ... 100 % (shown in picture: air speed 40 %, 4 bars lit up)

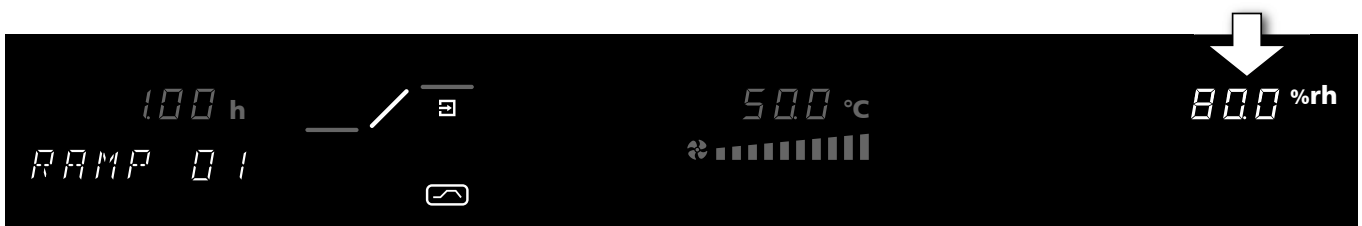

9. Setpoint humidity/humidity at end of ramp segment (only for CTC 256)

Adjustment range: 10 to 90 %rh (shown in picture: humidity 80.0 % rh)

Each ramp must be completed with a close command connecting the ramp to the next one. These commands thus control the programme sequence:

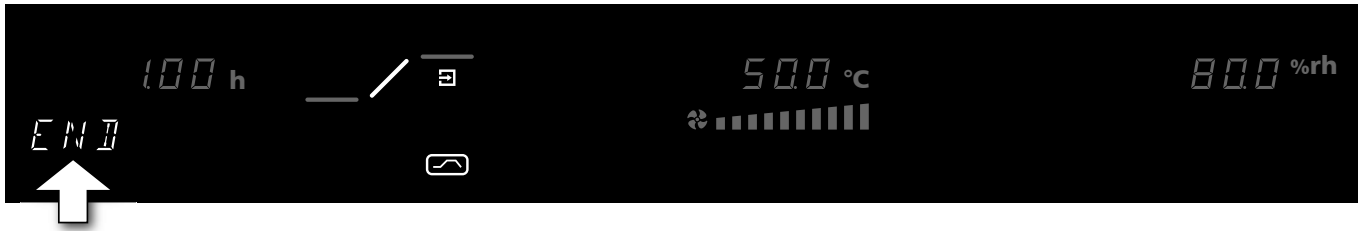

10. Close command of the ramp segment

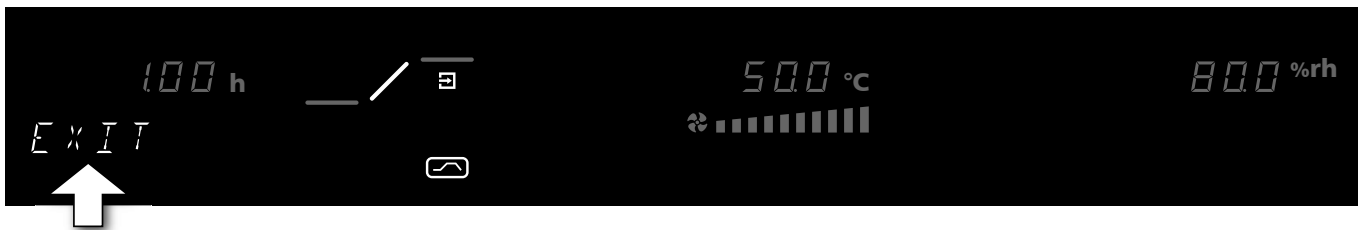

Setting: NEXT, SPWT (T), SPWT (H), SPWT (TH), LOOP, HOLD, END (shown in picture: Command End; see also chapter 5.8.6 Close commands for ramp segments on page 37).



11. Leave programming write mode EDIT



Turn push-turn control to the right until EXIT appears in the display, and press the SET key briefly to confirm.

After releasing the SET key,

- ▶ a new programme can be created as described above, or an existing one be edited with EDIT  EDIT
- ▶ stops the programme  STOP
- ▶ starts the programme  START

5.8.6 Close commands for ramp segments

Each ramp must be completed with a close command connecting the ramp to the next one. These commands thus control the programme sequence:

-  NEXT
Connect the next programme segment.
-  SET-POINT WAIT (T – Temperature)
Wait until setpoint has been reached.
Appliance starts the next programme segment only when the programmed setpoint temperature has been reached, even if the set heating up time has already elapsed.

SPWT (H) SET-POINT WAIT (H – humidity, only for CTC 256)
 Wait until setpoint humidity has been reached.
 Appliance starts the next programme segment only when the programmed setpoint humidity has been reached, even if the set heating up time has already elapsed.

SPWT (TH) SET-POINT WAIT (TH – temperature and humidity, only for CTC 256)
 Wait until setpoint temperature and setpoint humidity have been reached.
 Appliance starts the next programme segment only when the programmed setpoint temperature and programmed setpoint humidity have been reached, even if the set heating up time has already elapsed.

LOOP Ramp repeat function
 The programme entered is repeated after it has run through all programmed segments.
 1-99 = repeats
 CONT = endless repeat function

HOLD Programme end while maintaining the temperature and humidity of last programme ramp

END Programme end, switching off the heating /cooling function and humidity

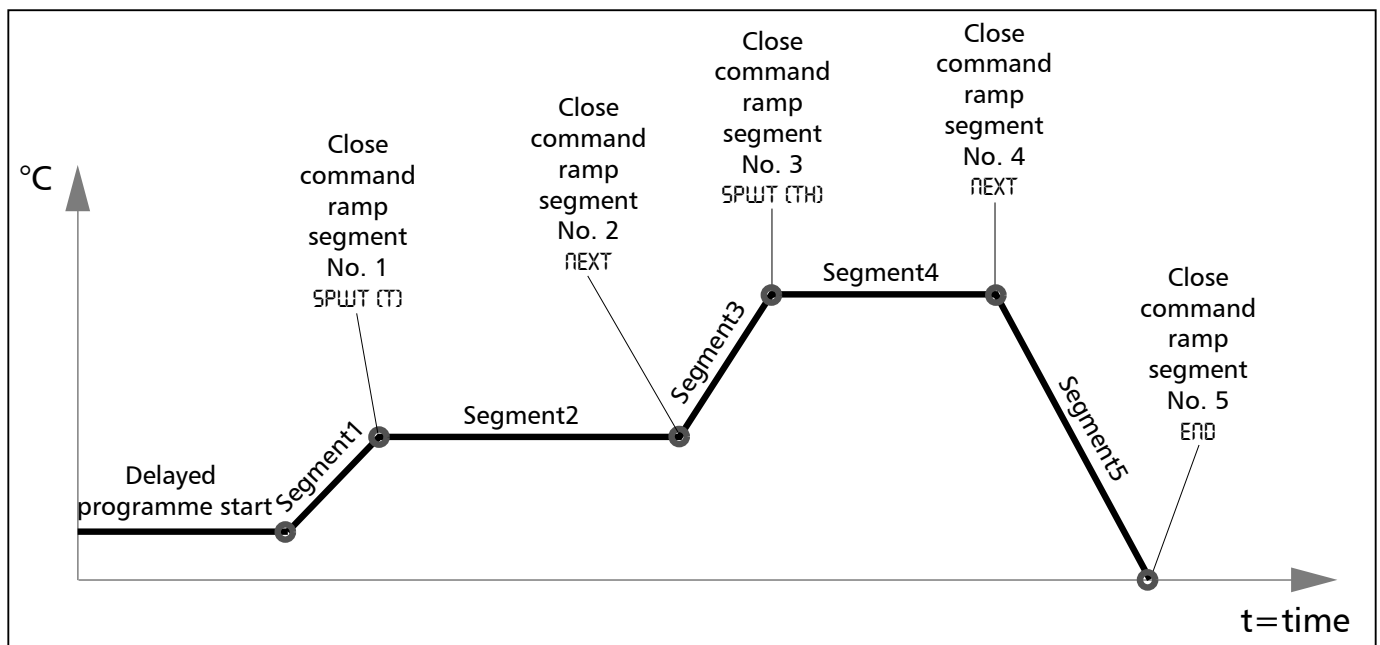

Fig. 24 Schematic example of the use of ramp segment close commands

5.8.7 Example setting programming mode

i For the TTC temperature test chamber there is no programming of humidity.

On Monday at 8.00, the test chamber should heat up to 50 °C as quickly as possible, with a fan speed of 40 %, and reach a relative humidity of 70 % rh. Once the temperature and humidity have been reached, the test chamber should retain the setpoint values for 45 minutes and then cool down within one hour to a humidity of 50 % rh and 37 °C (Fig. 25).

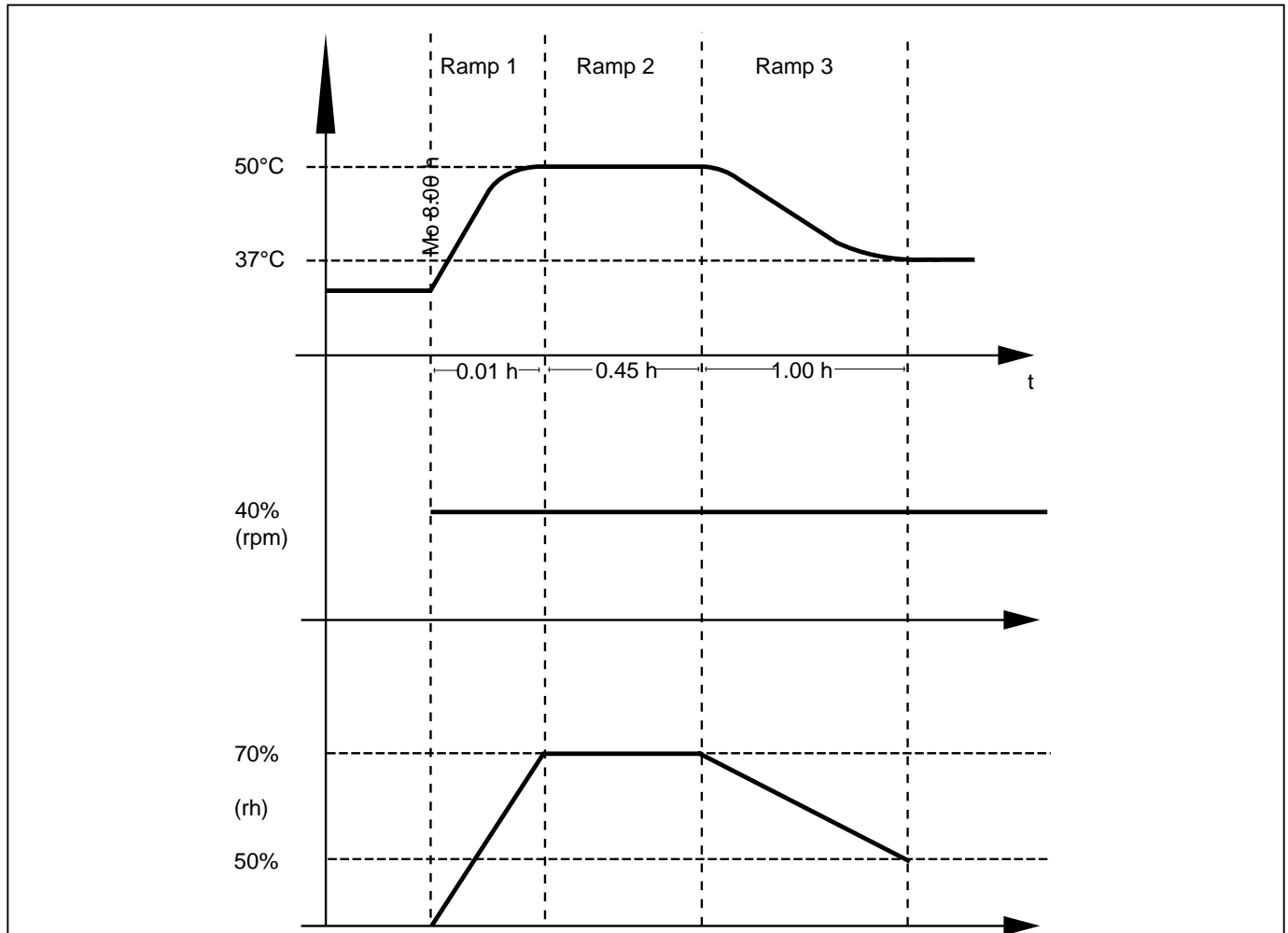
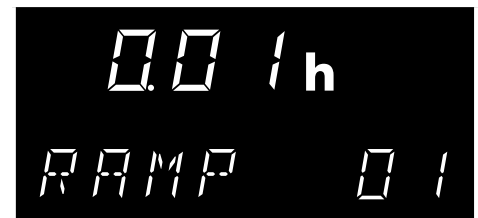

Fig. 25 Settings example for programming mode

i Before programming ramp sequences, especially complicated ones, it is recommended that you prepare a similar plan so that you enter the required ramp commands correctly, as described below. For the sake of retaining an overview, it is recommended that you programme large programmes graphically on the PC.

1. Setting the programming operating mode:
Hold the SET key down for approx. 3 seconds, the current operating mode then begins to flash. Select the programming mode operating mode with the push-turn control, while the SET key is held down. After releasing the SET key, the control is in the programming operating mode.
2. Editing the programme:
Select EDIT with the push-turn control, while the SET key is held down. After releasing the SET key, the controller is in the programming write mode.
3. Weekday for delayed programme start:
Set the start day **Mo** by turning the push-turn control while the SET key is held down.
4. Set the clock time for delayed programme start:
Select the time display with the push-turn control. Hold down the SET key and set the time to **08:00 AM** with the push-turn control.
5. Setting the duration of the first ramp segment:
Turn the push-turn control further to the right until the time display flashes. Hold down the SET key and set the time to **001** with the push-turn control.
6. Setting the temperature of the first ramp segment:
Turn the push-turn control to the right until the temperature display flashes. Hold down the SET key and set the desired temperature setpoint of **500 °C** with the push-turn control.
7. Setting the fan speed of the first ramp segment:
Turn the push-turn control to the right until the fan icon flashes. Hold down the SET key and set the fan speed of 40 % (4 bars) with the push-turn control.



8. Setting the relative humidity of the first ramp segment (only for CTC 256):

Turn the push-turn control to the right until the humidity display flashes.

Hold down the SET key and set the desired humidity setpoint of 70.0 % rh with the push-turn control.

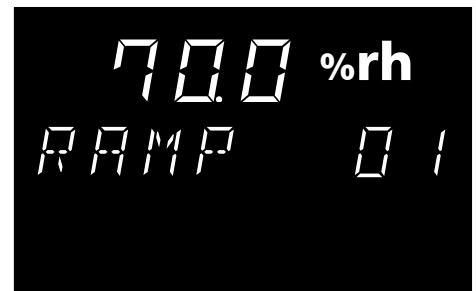

9. Setting the close command of the first ramp segment:

Turn the push-turn control to the right until a segment close command appears, e.g. END.

Hold down the SET key and set the close command SPLIT (TH) with the push-turn control.



10. Setting the duration of the second ramp segment:

Turn the push-turn control further to the right until the time display flashes.

Hold down the SET key and set the time to 12:45:00 AM with the push-turn control.



11. Setting the temperature of the second ramp segment:

Turn the push-turn control to the right until the temperature display flashes.

Hold down the SET key and set the desired temperature setpoint of 50.0 °C.



12. Setting the fan speed of the second ramp segment:

Turn the push-turn control to the right until the fan icon flashes.

Hold down the SET key and set the fan speed of 40 % (4 bars) with the push-turn control.



13. Setting the relative humidity of the second ramp segment (only for CTC 256):

Turn the push-turn control to the right until the humidity display flashes.

Hold down the SET key and set the desired humidity setpoint of 70.0 % rh with the push-turn control.



14. Setting the close command of the second ramp segment:

Turn the push-turn control to the right until a segment close command appears, e.g. END.

Hold down the SET key and set the close command NEXT with the push-turn control.

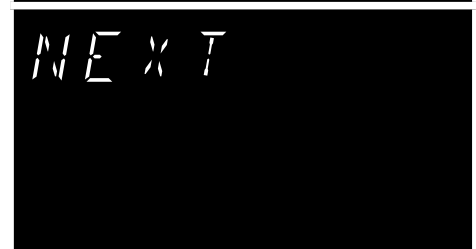

15. Setting the duration of the third ramp segment:
 Select the time display with the push-turn control.
 Hold down the SET key and set the time to 01:00:00 RPT with the push-turn control.

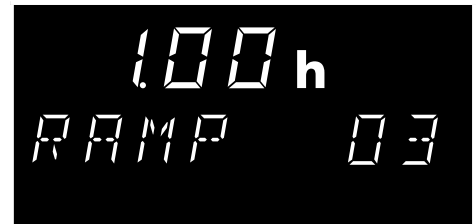

16. Setting the temperature of the third ramp segment:
 Turn the push-turn control to the right until the temperature display flashes.
 Hold down the SET key and set 37.0 °C with the push-turn control.

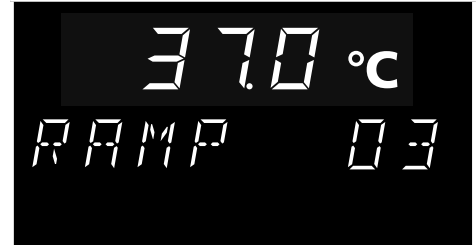

17. Setting the fan speed of the third ramp segment:
 Turn the push-turn control to the right until the fan icon flashes.
 Hold down the SET key and set the fan speed of 40 % (4 bars) with the push-turn control.

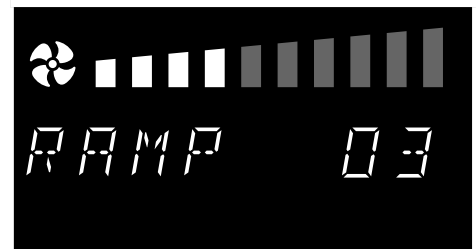

18. Setting the relative humidity of the third ramp segment (only for CTC 256):
 Turn the push-turn control to the right until the humidity display flashes.
 Hold down the SET key and set the desired humidity setpoint of 50.0 % rh with the push-turn control.



19. Setting the close command of the third ramp segment:
 Turn push-turn control to the right until a close command appears in the display, e.g. END, and press the SET key briefly to confirm.

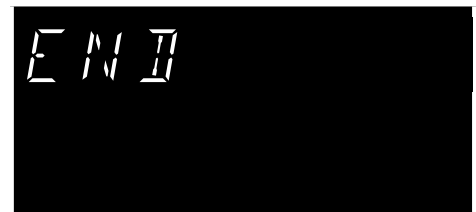

20. Leave programming write mode EDIT:
 Turn push-turn control to the right until EXIT appears in the display, and press the SET key briefly to confirm.



21. Setting the temperature monitoring:
 Turn the push-turn control to the right and adjust the temperature monitoring (for more detailed information on this, see page 48).

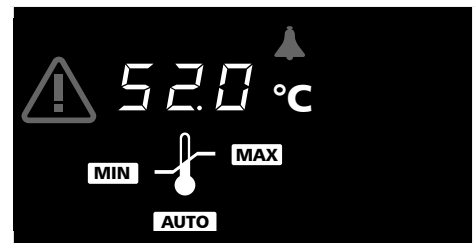

22. Starting the programme:
 Turn the push-turn control to the right until the stop icon ■ flashes.
 Hold down the SET key and select the start icon ► with the push-turn control. Release the SET key, and the programme is started.



5.8.8 Operation with PC/laptop (optional)

The test chamber can optionally be used, controlled and programmed with a PC/laptop. It has corresponding communication interfaces for this purpose (see page 55 and Fig. 3 on page 10).



The control of the appliance with the Memmert-PC software "Celsius" is described in its own separate manual.

5.9 Ending operation



Warning!

When opening the chamber door, hot steam may escape and scald you in the face. Remain behind the door when you open it and let out the steam, or allow the test chamber to cool down before opening the door.



Warning!

Depending on operation, the surfaces in the chamber interior and the chamber load may be very hot or very cold. You could suffer from burns or frostbite if you touch these surfaces. Allow the chamber interior to first adjust to room temperature after opening the door, or use heat-resistant protective gloves.



1. Switch off appliance. To do this, press the push-turn control on the operating panel so that it clicks into place in the appliance (see page 27).
2. Open door (see page 25).
3. Remove the chamber load.
4. Empty the condensation water tank as described on page 24. In addition, for CTC climatic test chambers, fill up the freshwater tank (see page 22).
5. Empty the drip tray (see Fig. 40 on page 63).

6. Malfunctions and error messages



Warning!

After removing covers, voltage-carrying parts may be exposed. You may receive an electric shock if you touch these parts. Malfunctions requiring intervention inside the appliance may only be rectified by electricians. Read the separate service manual for this.



Do not try to rectify the error yourself, but contact an authorised customer service point for MEMMERT appliances or contact the customer services department of the company MEMMERT directly (see page 2).

For service enquiries, please always specify the chamber type appliance number on the name-plate (see page 16).

6.1 Error in the temperature monitoring / humidity system

See chapter Warning messages on page 51 and Fig. 21 on page 28.



6.2 System/ appliance errors

Error	Possible causes	Rectification
Nothing shows on display although test chamber is switched on.	Power supply interrupted	Check power supply
	Appliance error	Contact Customer Service
Appliance cannot be operated	Test chamber locked with user-ID card	Unlock test chamber with user-ID card (see page 60).
 Icon flashes	Temperature monitoring (TWW, ASF) has been triggered	See chapter Temperature monitoring and safety equipment from page 48
 Icon flashes and display RH EMPTY	Water tank empty	Fill water tank (see page 22)
Error (E...) in display	Appliance / system error	Contact Customer Service
Chamber interior and external fan not working	Mains adapter defective	Contact Customer Service
Temperature fluctuates	Cooling unit iced up	Set shorter defrosting intervals in SETUP - DEFROST (see Kapitel 7.5 Automatic defrosting system auf Seite 54
Temperature cannot be set lower than 10 °C or not higher than 95 °C.		Disable humidification and dehumidification by setting humidity setpoint to "OFF".

Error	Possible causes	Rectification
Insufficient cooling power	Air inlet/outlet blocked	Ensure that the fan opening on the front side of the appliance is not covered (see page 10)
	Air filter soiled	Clean air filter (see page 63)
	Cooling unit iced up	Set shorter defrosting intervals in SETUP - DEFROST (see Kapitel 7.5 Automatic defrosting system auf Seite 54)
	Too little refrigerant	Contact Customer Service
Air humidity cannot be adjusted (only for CTC climatic test chambers)	Reliable climatic range exceeded/exceeded	Set temperature setpoint within climatic range, from 10 °C–95 °C, afterwards set the relative humidity.

6.3 Power failure

In case of a power failure, the test chamber behaves as follows:

In normal  and week time switch  operating modes

After the power supply has been restored, operation is continued with the parameters set. The time and the duration of the power failure is documented in the log memory (see page 57).

In programming mode 

- ▶ After a power failure of less than 60 minutes, the current programme is continued from the point at which it was interrupted. The time and the duration of the power failure is documented in the log memory (see page 57).
- ▶ After a power failure of more than 60 minutes, the test chamber starts in manual operating mode for safety reasons and all setpoint values are changed to safe default values (see table below).

For remote (PC) operation

If there is a power failure in remote operation, the test chamber starts in manual operating mode for safety reasons and all setpoint values are changed to safe default values (see table).

Continuing the programme can only be done from the PC. The time and the duration of the power failure is documented in the log memory (see page 57).

Parameter	Default value
Temperature	20 °C
Humidity (only for CTC 256)	20 % rh
Fan speed	maximum

7. Advanced functions

7.1 Printer

The test chamber is equipped with a parallel printer port as standard, just as used in computers.

A standard PCL3-compatible inkjet printer which has a parallel port interface (e.g. HP DeskJet 5550 or HP DeskJet 9xx) can be connected to the printer port on the left of the test chamber (see page 11).

Make sure that a shielded interface cable is used. The shielding must be connected to the plug casing.

The controller has an internal log memory (see page 57). The log data can be printed out in this mode via the connected printer.

If a colour printer is connected, the various graphs are printed out in colour.

For a printout, the GLP header is also printed automatically, and contains the following details:

- ▶ Date of printout
- ▶ Period of logging
- ▶ Consecutive page numbers
- ▶ Serial numbers and appliance name

By turning the push-turn control and holding down the SET key, the following parameters can be selected and altered one after another, as described in Chapter 5.6.3 Basic operation on page 29:

Querying the date of the first print page

Querying the date of the last print page

Start graphical printout

Print programme and configuration page

Leaving the print menu and returning to the main menu

7.2 Basic appliance settings (Setup)

In this operating mode, the basic settings for the appliance can be made.



By turning the push-turn control and holding down the SET key, the following parameters can be selected and altered, as described in Chapter 5.6.3 Basic operation on page 29:

Clock time in 24 hr. format

i Conversion to summer time is not automatic, but must be done manually

Date

The controller contains a calendar which automatically accounts for the different lengths of months, and for leap years.

Weekday

Year

Adjustment range: From 2000 to 2100

Acoustic signal at programme end

ENDSOUND

Setting: OFF oder ON

Acoustic signal for alarm, e.g. over/undertemperature

ALARM SOUND

Setting: OFF or ON

Communication address

Adjustment range: 0 bis 15 (see Chapter 7.6 Communication interfaces on page 55)

Tolerance band ASF

Adjustment range: 2 to 20 °C (see page 49)

Language

Setting: GERMAN, ENGLISH, FRANCAIS, ESPANOL und ITALIANO

Compensation correction values (CAL 1-3, RH20, RH90) for calibration of temperature and humidity at customer site

Chapter 7.4 Calibration on page 51)

Automatic defrosting system

(for details on settings, see page 54)

Leave Setup

Save all settings and leave the SETUP mode

The real time clock which is set in the SETUP contains the date and clock time. The real time clock is used for logging purposes in accordance with GLP. Date and clock time are specified on the log printout. On graphical printouts, the time axis is labelled with the real time. The clock is battery-buffered and independent of the mains connection. The integrated lithium battery of the type CR 2032 has a lifetime of approx. 10 years.

3005

SET DATE

Tu

SET DAY

2006

SET YEAR

OFF ON

ENDSOUND

OFF ON

ALARM SO

ADDRESS

ASF SET

GERMAN

CAL. 1

rh 20

DEFROST

EXIT

7.3 Temperature monitoring and safety equipment

The monitoring temperature is measured via a separate Pt100 temperature sensor in the chamber interior. The monitoring unit is used to protect the chamber load and as a protection for the appliance and surroundings.

Temperature monitoring can be adjusted independently of the operating modes.

i In ramp operation mode the monitoring temperature must always be set at least 3 K above the maximum working temperature.

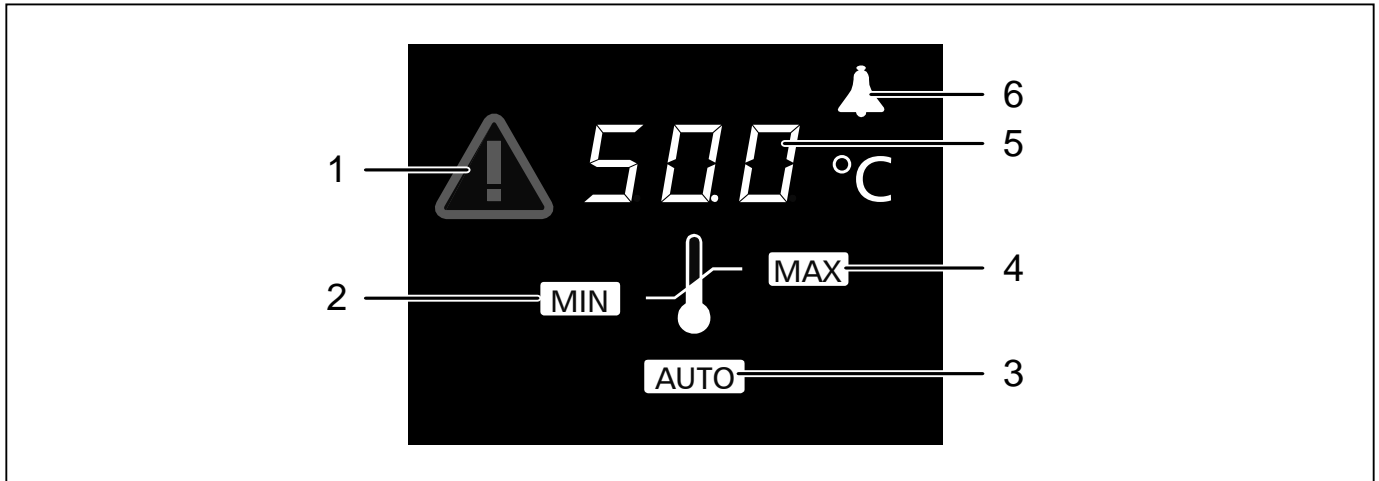

Fig. 26 Temperature monitoring display

- 1 Visual alarm icon
Lit up: TB alarm
Flashing: TWW alarm, TWB alarm, ASF alarm
- 2 Undertemperature limit
- 3 Automatic temperature monitor (ASF, see page 48)
- 4 Overtemperature limit (TWW, TWB, see below)
- 5 Trigger temperature
- 6 Acoustic alarm icon

7.3.1 Electronic temperature monitoring (TWW)

Overtemperature limit

Adjustment range: -50 ... +200 °C

Setting:

Select the **MAX** icon with the push-turn control.

Hold down the SET key and adjust the temperature limits with the push-turn control.

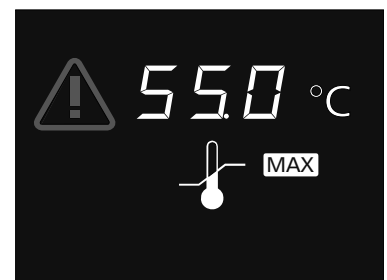

Undertemperature limit

Adjustment range: -50 ... +200 °C

Setting:

Select the **[MIN]** icon with the push-turn control. Hold down the SET key and adjust the temperature limits with the push-turn control.

i The lower alarm limit value cannot be set higher than the top one. If no undertemperature limit is required, set the lowest temperature.

The undertemperature and overtemperature control **[MIN]** and **[MAX]** is monitored by an adjustable over/undertemperature controller (TWW) protection class 3.3 acc. to German standard DIN 12880.

If the manually set monitoring temperature **[MAX]** is exceeded, the TWW takes over temperature control and begins to regulate the monitoring temperature. The alarm icon **⚠** flashes as a warning.

If the acoustic alarm is switched on in the SETUP (see Chapter 7.2), the TWW alarm is additionally signalled by a repeated acoustic signal. If the SET key is pressed, the signal can be temporarily switched off until the next alarm event occurs

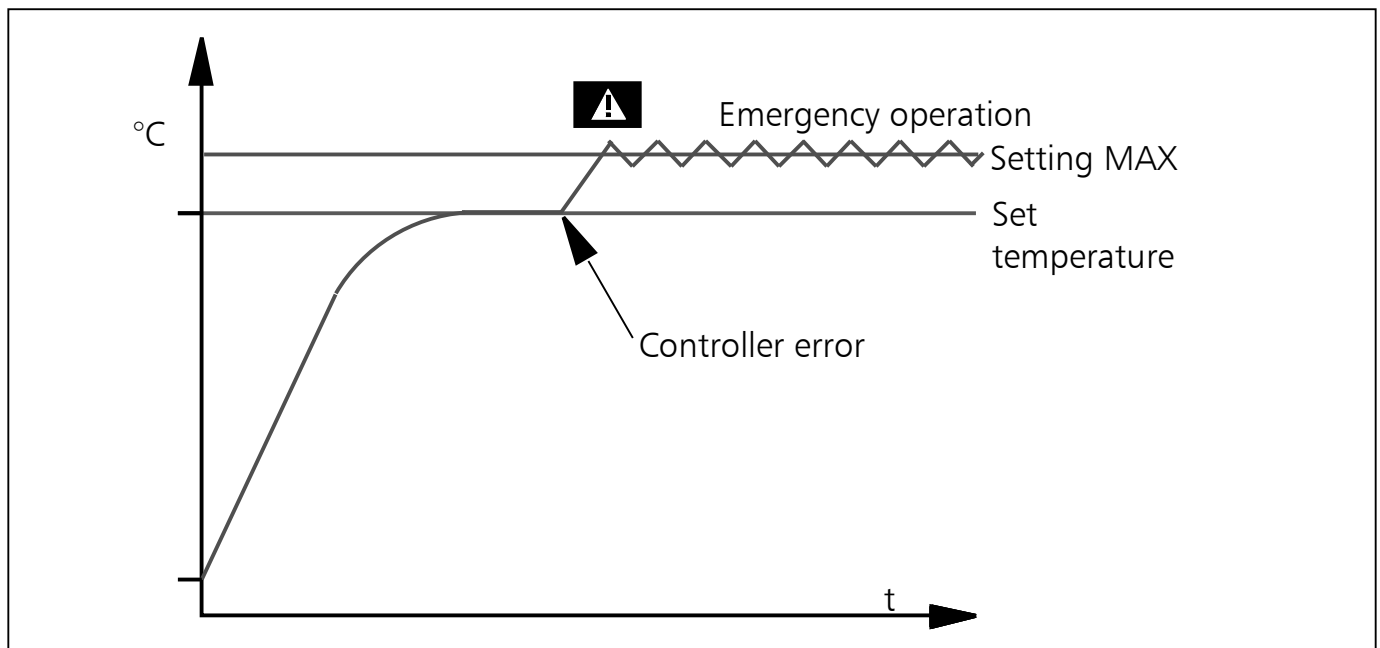
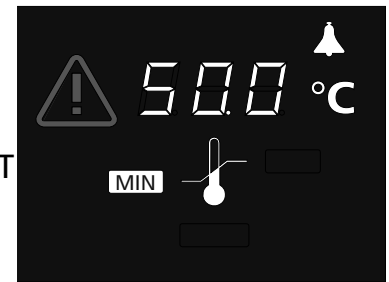

Fig. 27 Schematic diagram of how the TWW temperature monitoring functions

7.3.2 Automatic temperature monitor (ASF)

ASF is a monitoring device that automatically follows the set temperature setpoint within an adjustable tolerance band (Fig. 28).

If switched on, the ASF is activated automatically if the actual temperature value reaches 50 % of the set tolerance band of the setpoint (in the example 50 °C ± 1 °C) for the first time (section A). The activation of the ASF is shown by the brightly lit **[AUTO]** icon.

When the temperature moves outside the set tolerance band around the setpoint (in the example in Fig. 28: 50 °C ± 2 °C) – e.g. if the appliance door is opened during operation (section B of illustration) – the alarm is set off. This is shown by the flashing icons **[AUTO]** and **⚠**. If the acoustic alarm is switched on in the SETUP (see Chapter 7.2), the ASF alarm is additionally signalled by a repeated acoustic signal. If the SET key is pressed, the signal can be temporarily switched off until the next alarm event occurs.

The ASF alarm goes off automatically as soon as 50 % of the set tolerance band of the setpoint (in the example 50 °C ± 1 °C) is reached again (section A).

If the temperature setpoint is altered, the ASF is automatically disabled temporarily (see in the example: The setpoint is changed from 50 °C to 25 °C, section D), until it has reached the tolerance range of the new temperature setpoint (section E).

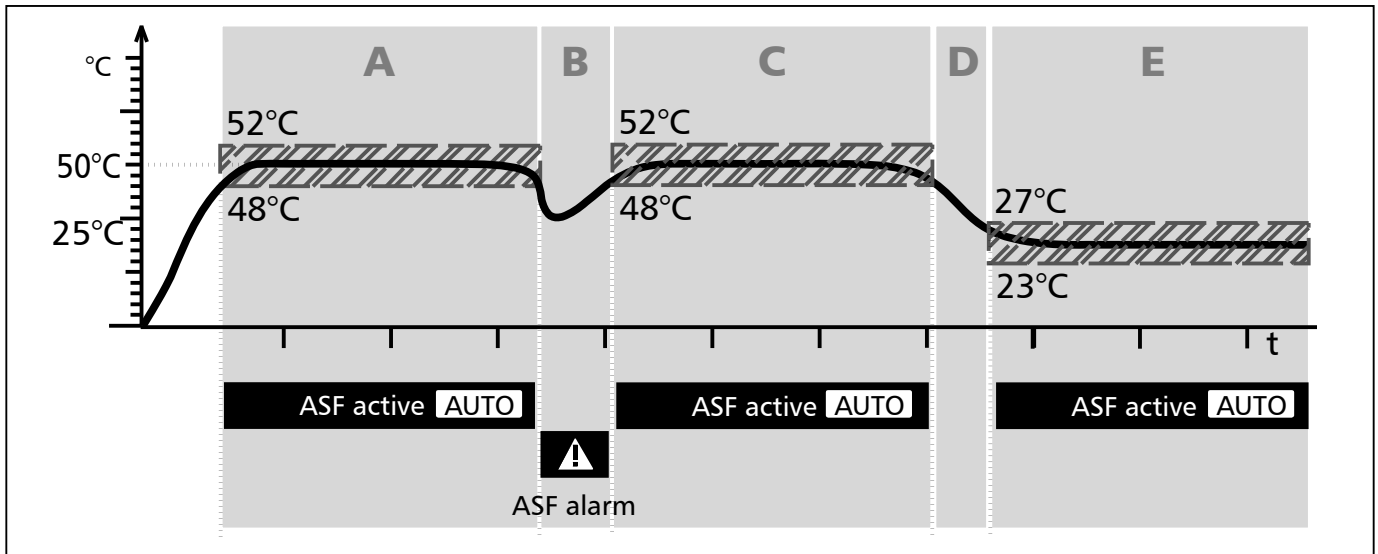
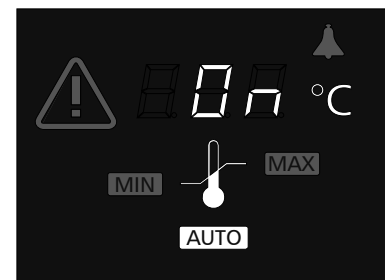

Fig. 28 Schematic diagram of how the ASF temperature monitoring functions

Switching on the automatic temperature monitor:

Select the AUTO icon with the push-turn control.

Hold down the SET key and set to on with the push-turn control.



Switching off the automatic temperature monitor:

Select the AUTO icon with the push-turn control.

Hold down the SET key and set to off with the push-turn control.

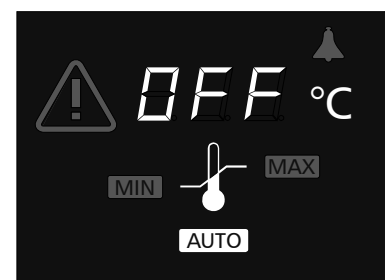

i The tolerance band for the ASF can be set in the SETUP in the range 2 ... 20 °C (see Chapter 7.2 Basic appliance settings (Setup) on page 46).

7.3.3 Warning messages

A repeated acoustic signal indicates an error in the temperature control system or in the humidification system. It is set off in the following cases:

HI-ALARM

Overtemperature limit is triggered. Check the MAX setting and increase if necessary (see Chapter 7.3.1 Electronic temperature monitoring (TWW) on page 48).

LO-ALARM

Undertemperature limit is triggered. Check the MIN setting and reduce if necessary (see Chapter 7.3.1 Electronic temperature monitoring (TWW) on page 48).

ASF-ALARM

Automatic monitoring function is triggered. Check the ASF-SET limit value in the SETUP menu (see Chapter 7.2 Basic appliance settings (Setup) on page 46).

AH EMPTY

Water tanks are empty. Fill up with water (see page 22).

AH OVER

Humidity exceeds the preset setpoint for longer than 30 minutes. Open door for 30 sec. and wait to see if the controller steadily adjusts to the setpoint. If the error occurs again, contact Customer Service.

i This monitoring function only starts to work once the humidity setpoint has been reached.

The acoustic alarm can be temporarily switched off by pressing the SET key.

7.3.4 Safety and monitoring equipment for the cooling unit

A high pressure limiter and a low pressure monitor protect the cooling unit from inadmissible operating pressure. When the high pressure limiter is triggered, the heaters and seals are switched off, and the caution icon lights up.

The condensation pressure is controlled by the automatic speed adjustment of the condenser fan. The fan can therefore automatically run faster or slower in operation, depending on the thermal energy extracted. The condenser fan may continue running for a short time after the main switch has been turned off, to cool down the condenser.

The condenser is fitted with an overheating limit. If the motor current increases, together with an increase in the coil temperature, the condenser is switched off. After the coil temperature has fallen, the overheating limit switches off automatically.

7.4 Calibration

7.4.1 Temperature calibration

The test chamber can be calibrated customer-specifically using three calibration temperatures of your choice:

- ▶ CAL.1 Temperature calibration at low temperature
- ▶ CAL.2 Temperature calibration at medium temperature
- ▶ CAL.3 Temperature calibration at high temperature

For each selected balance point (Fig. 29), a positive or negative compensation correction value can be set between -4.9 °C and $+4.9\text{ °C}$. There must be a difference of at least 10 °C between each of the individual balance points.

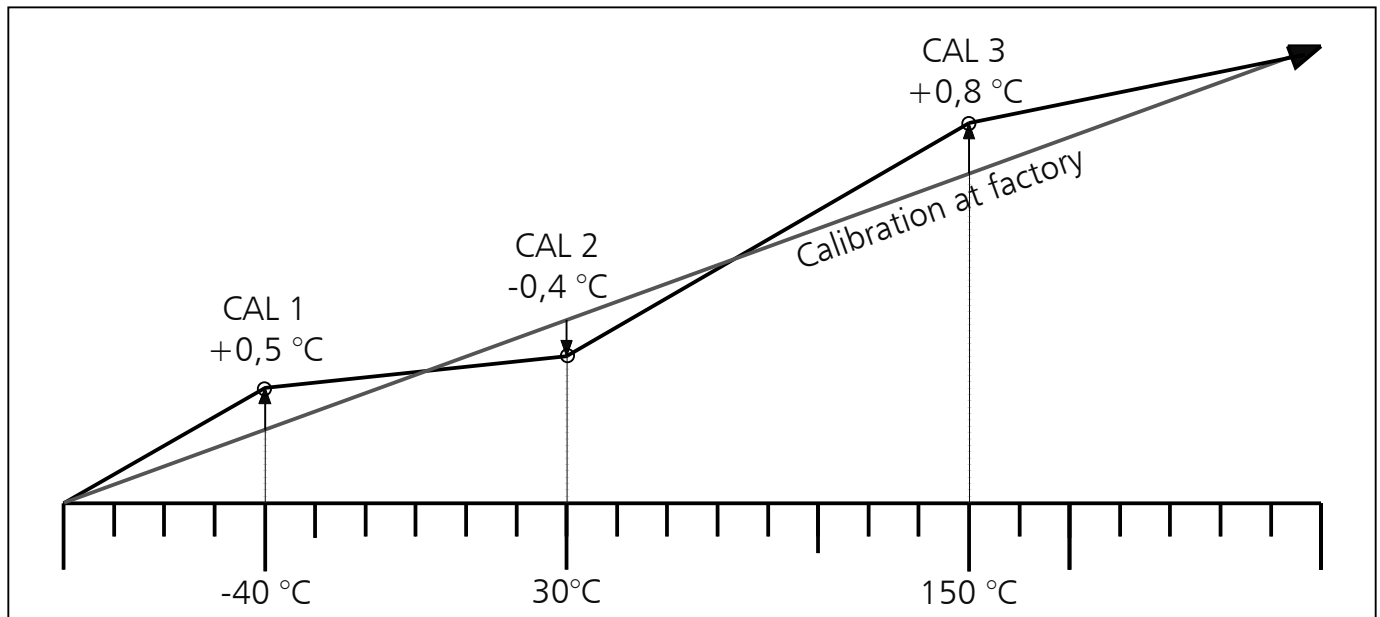

Fig. 29 Temperature calibration (example)

Setting:

1. Set the desired compensation temperature in the SETUP (see Chapter 7.2 Basic appliance settings (Setup) on page 46) and set the corresponding compensation correction value to 0.0 °C.
2. With a reference instrument, measure the deviation in the stationary state in the selected compensation temperature.
3. Setting the compensation correction values in the SETUP. If the measured reference temperature is too low, the compensation correction value must be set with a negative sign.
4. Perform a control measurement with the reference instrument.
5. Repeat the procedure for the other two balance points if necessary.

Example: Temperature deviation at 30 °C should be corrected.

1. Set compensation temperature [CAL2] in the SETUP to 30.0 °C and set the accompanying compensation correction value to 0.0 °C:



2. At a set setpoint temperature of 30 °C in normal operation, an actual temperature of 29.6 °C is measured with a calibrated reference instrument.
3. Set the compensation correction value for [CAL2] in the SETUP to -0.4 °C:



4. The reference instrument should now display 30 °C after the calibration procedure.
 5. With [RL1], another compensation temperature below [RL2] can be programmed in the same way, and with [RL3], one above it.
- i** If all compensation correction values are set to 0.0 °C, the factory calibration settings are restored.

7.4.2 Humidity calibration (only for CTC 256)

The test chamber can be calibrated for the individual customer by means of two balance points at 20 and at 90 % relative humidity. For each selected balance point, a positive or negative compensation correction value can be set between and -10 % and +10 %.

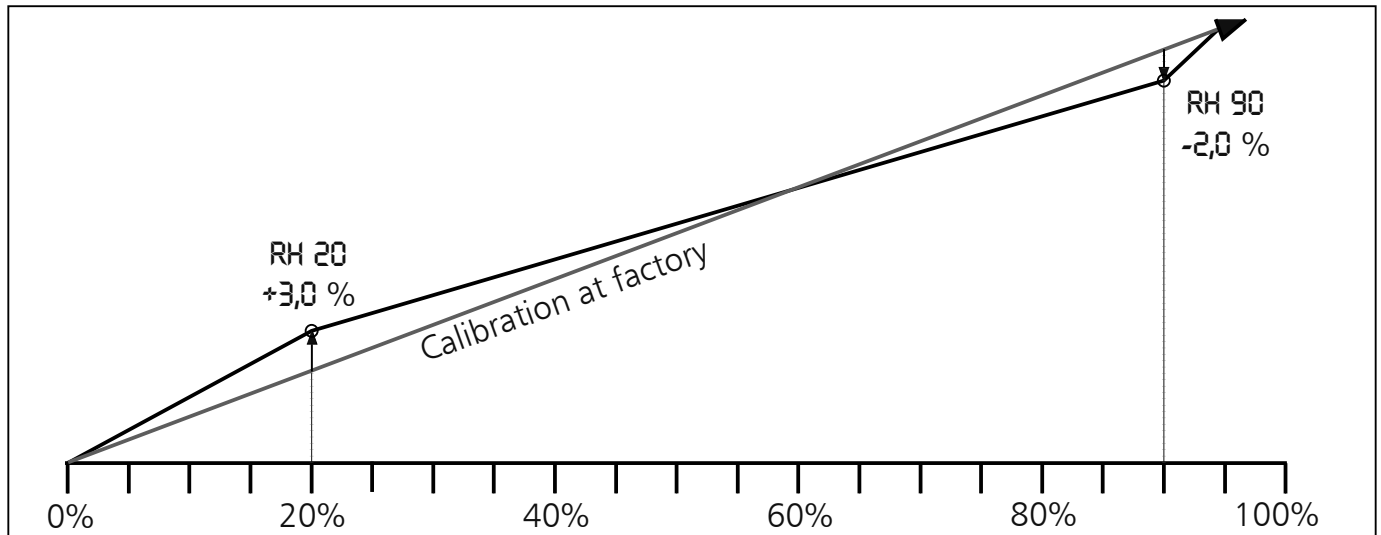

Fig. 30 Humidity calibration (example)

Setting:

1. Set the desired humidity balance point in the SETUP (see Chapter 7.2 Basic appliance settings (Setup) on page 46) and set the corresponding compensation correction value to 0.0 °C.
2. With a reference instrument, measure the deviation in the stationary state in the selected humidity balance point.
3. Setting the compensation correction values in the SETUP. If the measured reference humidity is too low, the compensation correction value must be set with a negative sign.
4. Perform a control measurement with the reference instrument.

The procedure can be performed with humidity balance points of 20 % rh and 90 % rh.

Example:

Humidity deviation at 90 % should be corrected.

1. Set humidity balance point in the SETUP to RH 90 and set the accompanying compensation correction value to 0.0 %rh:



2. With a calibrated reference instrument, an actual humidity of 88 % rh is measured at normal operation, with a set setpoint humidity of 90 %rh.
3. Set the compensation correction value in the SETUP for RH 90 to -20 %rh:



4. The reference instrument should display 90.0 % rh after the calibration procedure.

With RH 20, a further comparison can be programmed at 20 % relative humidity.

- i** If all compensation correction values are set to 0.0 RH, the factory calibration settings are restored.

7.5 Automatic defrosting system

The integrated automatic defrosting system for the cooling unit ensures the perfect running of the test chamber at low temperatures and in permanent operation. The time values for the automatic defrosting system are set in the SETUP submenu under DEFROST (see Chapter 7.2 Basic appliance settings (Setup) on page 46). If the device is defrosted, DEFRO is displayed (see page 28).

For long-term operation with a working temperature below +10 °C, or with a damp chamber load and/or with the door opened frequently, ice can form on the condenser over time. Heavy icing may impair the function of the appliance and could damage the cooling system. The automatic defrosting system can eliminate this formation of ice, at chosen intervals of 3, 6, 12, 24 or 48 hours. The factory setting is every 12 hours.

Because of this automatic defrosting, there is a minor brief increase in the chamber temperature at regular intervals. If you would like to further reduce this detraction in performance, you can lengthen the defrosting frequency, e.g. to every 24 hours.

In this case you should check to see if there is a permanent drop in the cooling performance or a strong fluctuation of the actual value, which may be an indication that the cooling unit is icing over.

If this is the case, please set the automatic defrosting system one level higher.

If humidity/room temperature are particularly high, it is possible that the factory default for defrosting, 12 hours, is not sufficient. In this case you should set a more frequent defrosting interval, e.g. every 6 hours.

The automatic defrosting is disabled with the OFF parameter. When operating at low temperatures this causes the cooling unit to ice over over time.

When operating the chamber with a chamber load which itself emits warmth to the interior, the automatic defrosting system should be disabled, otherwise one has to be prepared for the fact that the temperature in the interior will rise considerably during the defrosting cycle. A defrosting cycle can take up to 10 minutes. During this period the fan is switched off, no cooling takes place and there is no compensation for heat loss.

7.6 Communication interfaces

Depending on the specifications, the test chamber can be fitted with different communication interfaces (USB, RS 232/485, Ethernet). These are located on the left side of the appliance, in the base (see Fig. 3 on page 10 and Fig. 4 on page 11).

7.6.1 USB interface

The chamber is fitted by default with a USB interface in accordance with the USB specification. With this interface, it is possible to control and log the chamber remotely from the PC. This is done with the help of the "Celsius" software.

To do so, the chamber must be given a unique device address in the SETUP submenu, menu item ADDRESS, via which the PC communicates with the chamber. The standard setting is ADDRESS 0. The climatic chamber can be selected and programmed with this.

If several chambers are to be connected to a PC via USB interface, an appropriate interface on the PC and a separate cable are required for each chamber.

The maximum cable length is 5 m.

7.6.2 Communication interfaces RS232/RS485 (optional)

Instead of a USB interface, the chamber can be optionally equipped with an RS232 serial communication interface in accordance with German standard DIN 12900-1 or an RS485 interface.

- ▶ With the RS232 interface, it is possible to control and log the chamber remotely from the PC. If several chambers are to be connected to a PC via RS232 interface, an appropriate interface on the PC and a separate cable are required for each chamber. The maximum cable length is 15 m.
- ▶ The RS485 interface enables the networking of several chambers (up to 16) with one PC via a shared two-wire cable. The PC needs to be equipped with either a RS485 interface or with an RS232/RS485 adapter. Connecting the wires is done individually with a shielded cable, depending on the installation site. The maximum total cable length is 150 m.

In both cases, each chamber must be given a unique device address in the SETUP submenu, menu item ADDRESS (see Chapter 7.2), via which the PC communicates with the chamber. The standard setting is ADDRESS 0. Using this address, the appropriate oven can be selected and programmed from the PC.

The test chamber can be connected to the PC using a shielded interface cable. The shielding must be connected to the plug casing.

i If the serial port is not used, put on the cover included.

7.6.3 Connection of test chambers to a network with Ethernet interface

The test chamber can optionally be equipped with an Ethernet instead of a USB interface.

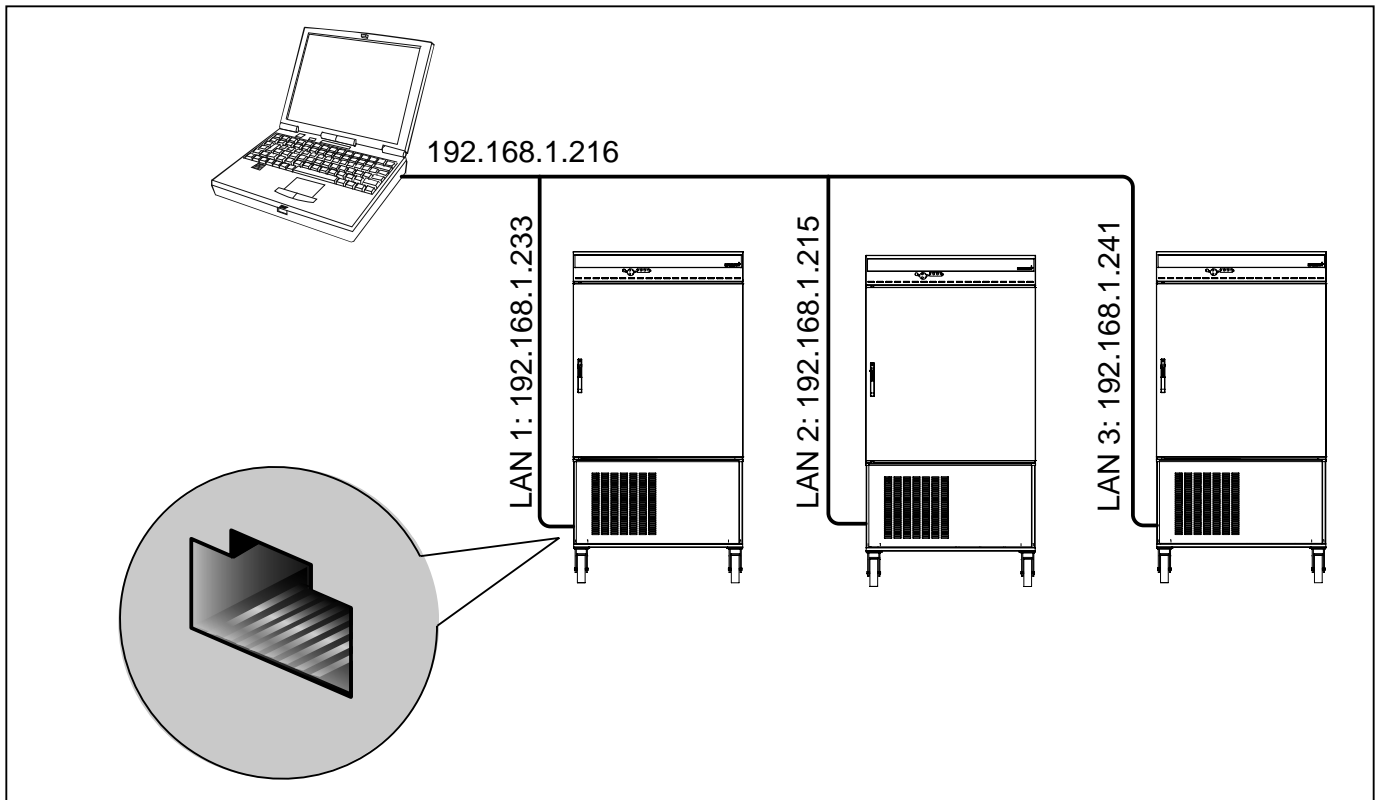

Fig. 31 Connecting one or more test chambers to a network using an Ethernet interface (schematic diagram)

For identification purposes, each appliance connected must have its own unique IP address. Each chamber is delivered by default with the IP address 192.168.100.100. The programme "XTADMIN", which can be found on the "Celsius Ethernet" CD-ROM, can be used to change the IP address.



How to set the IP address is described in the supplied manual for "Celsius".

7.6.4 Log memory

The controller continually logs all relevant measured values, settings and error messages at 1-minute intervals. The internal log memory is listed as a ring memory, i.e. the oldest log data are always overwritten automatically with new data.

The logging function cannot be switched off, but is always active. The measured data are stored in the controller, safe from manipulation. For documentation purposes the controller memory can be read out via the Celsius control software. Each dataset is stored with a unique timestamp.

The internal log memory has a size of 1024 kB. This corresponds to a storage capacity for about three months in permanent operation.

Since large amounts of data are stored during ramp mode, this can reduce the maximum logging time.

If the power supply is interrupted, the time of the power cut and the return of voltage are stored in the controller.

Reading in the log memory to the PC via USB interface

The log data can be read out either via the USB interface and then printed out from the PC or via a connected PCL3-compatible printer.

Using the "Celsius" programme the log memory of the controller can be read out to a PC and from there be displayed graphically, printed out and stored.



The log memory of the controller is not modified or deleted by the reading out.

Printing out log memory

(see also Chapter Printer on page 46)

For a printout, the GLP header is also printed automatically, and contains the following details:

- ▶ Date of printout
- ▶ Period of logging
- ▶ Consecutive page numbers
- ▶ Serial numbers and appliance name



If the printer is not ready (e.g. ink cartridge or paper tray empty), no log data will be lost. Multiple printouts can also be made, since the log memory is not deleted after printing.

7.6.5 MEMoryCard XL

On the MEMoryCard XL (Fig. 32) a temperature control programme with up to 40 ramp segments can be set up (see page 35).

This can be programmed directly on the controller or via the "Celsius" software.



To programme the MEMoryCard XL with the PC and the "Celsius" software, please read the user manual for "Celsius" or the online help.

For the sake of retaining an overview, it is recommended that you programme large programmes graphically on the PC. If a MEMoryCard XL is programmed, it can only be read in the same type of chamber for which it was programmed.

The text field of the MEMoryCard XL can be filled individually with text or diagrams.

Directly programming the MEMoryCard XL via the test chamber

1. Push the MEMoryCard XL into the card reader in the appliance operating panel (see Fig. 20 on page 28).
2. Programme the chamber as described in Chapter 5.7. The chosen settings are written directly to the card and stored on it. After the card is removed, the programme stored internally in the controller is activated again.

Programming the MEMoryCard XL from the PC with the test chamber

1. Connect the PC to the chamber's USB interface with an interface cable (see Chapter 7.6.1 USB interface on page 55).
2. Push the MEMoryCard XL into the card reader in the appliance operating panel (see Fig. 20 on page 28).
3. Programme the chamber on the PC. The chosen settings are written to the card and stored on it.

- i** Via the "Celsius" software, the MEMoryCard XL can be provided with a write protection. The programme on the card can then no longer be altered on the controller. Programme alterations via the controller are only possible if the write protection has been disabled from the PC with the "Celsius" software.

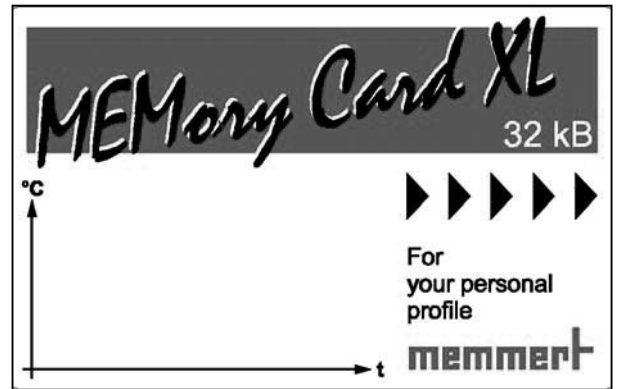

Fig. 32 MEMoryCard XL

Programming the MEMoryCard XL from the PC with read-write device

Using the card reader which can be purchased separately (Fig. 33), the MEMoryCard XL can be programmed offline from the PC with "Celsius" without the need for a test chamber being connected. When you do this, make sure that the contacts on the MEMoryCard XL are pointing upwards to the markings on the card reader.

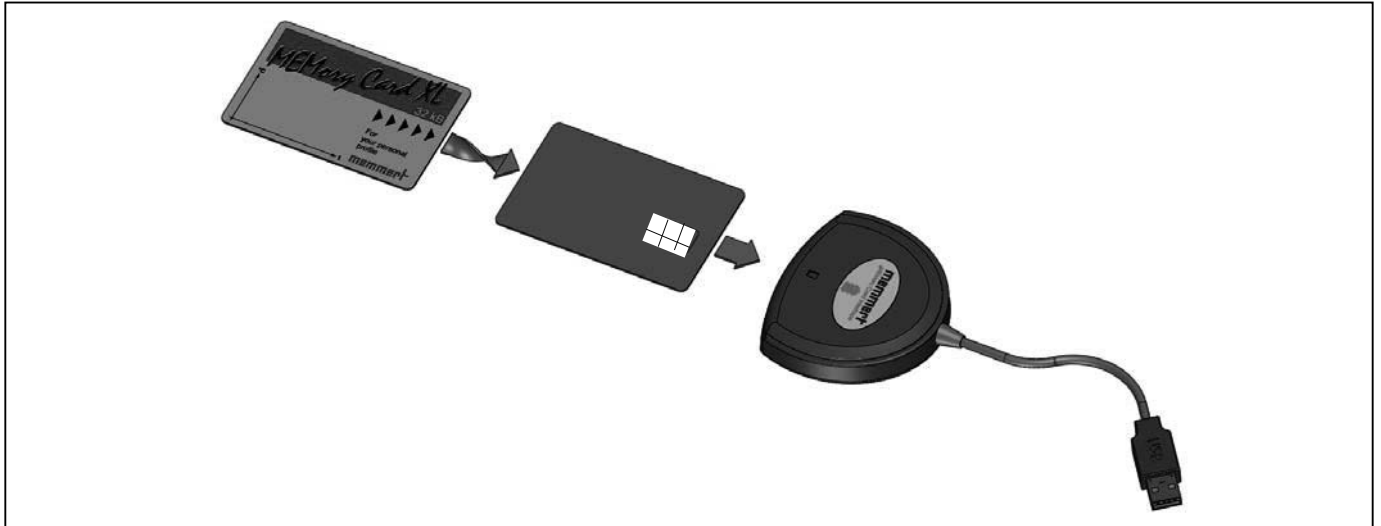

Fig. 33 Read-write device

i The programme remains stored on the MEMoryCard XL even after it is removed from the appliance. It can also be overwritten at any time with "Celsius" via the PC.

Logging on the MEMoryCard XL memory card

When a programme sequence from the chip card is running, the humidity and temperature setpoints are continually logged on the memory card. These can be read in via "Celsius" after the programme is finished and printed out. This is described in the "Celsius" user manual.

There is certain amount of storage space available for logging, depending on the programme length.

The scanning is set automatically by the controller, depending on the programme duration.

The actual value can be logged on the MEMoryCard XL, at one minute intervals, for a programme lasting up to 135 hours. For programmes lasting longer, the scanning rate is lengthened to a maximum of 30 min.

i For each programme start the logging is restarted, and old log data is overwritten.

7.6.6 User ID card (optionally available as an accessory)

The device number of the appliance and a unique user number are stored in encrypted form on the user-ID card (Fig. 34). The user-ID card therefore works only in the appliance with the corresponding serial number.

Every login process with the user-ID card is logged in the internal Flash memory of the controller.

If the user-ID card has been inserted, the menu item **ID-LOCK** also appears in the SETUP menu (see Chapter 7.2 Basic appliance settings (Setup) on page 46). If the setting is set to **ON**, the test chamber is locked against all alterations once the card is removed.

The lock via the user-ID card is displayed via the flashing key icon  on the operating panel (see also Fig. 21 on page 28).

- i** If the test chamber is locked via the user-ID card, no programme operation with the MEMoryCard XL is possible, since this card could be removed at any time and modified externally.

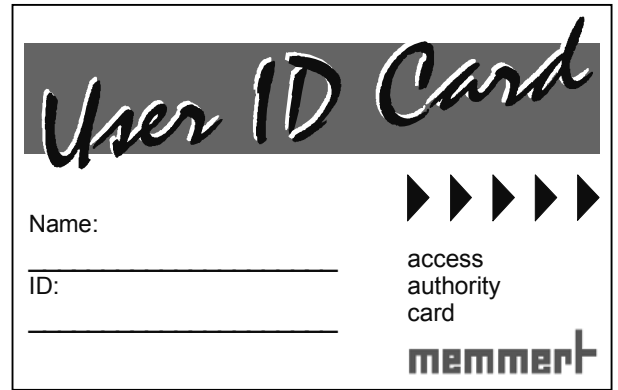
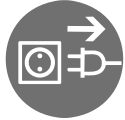

Fig. 34 User-ID-Card

8. Maintenance and Servicing

**Warning!**

Depending on operation, the surfaces in the chamber interior may be very hot or very cold. You could suffer from burns or frostbite if you touch these surfaces. Before any maintenance / cleaning work, allow time for the chamber interior to reach room temperature.

**Warning!**

Disconnect the power plug before any cleaning or maintenance work.

8.1 Basic cleaning

Regular cleaning of the easy-to-clean chamber interior, prevents build up of material remains, which over time could impair the appearance and functionality of the stainless steel chamber.

The metal surfaces of the chamber can be cleaned with normal stainless steel cleaning agents. Make sure that no rusty objects come into contact with the working chamber or with the stainless steel housing. Rust deposits lead to an infection of the stainless steel.

If rust spots should appear on the surface of the working chamber, due to impurities, immediately clean and polish the affected area.

Do not clean the operating panel, the plastic input module and other plastic parts of the chamber with abrasive or solvent-based cleaning agents.

8.2 Intensive cleaning

Cleaning surfaces of the interior that are otherwise not accessible is possible after the side walls and rear wall have been dismantled:

1. Pull out the silicone plugs, remove the 8 Allen screws each on the left and right side walls and remove the walls (Fig. 35).
2. Pull both temperature sensors from their sockets and let them hang down (Fig. 36, A).
3. Dismantle the rear wall of the test chamber; to do this, remove the 4 screws in the corners and 2 screws beneath the fan and pull out the metal plate at an angle (Fig. 36). Make sure that the temperature sensors are guided through the opening in the steel plate and remain in the interior.
4. The exposed surfaces can now be cleaned.
5. When cleaning is finished, push the rear wall at an angle back into the test chamber. Thread the two temperature sensors through the opening in the metal sheet (Fig. 36, A).
6. Tighten the test chamber rear wall with 6 screws.
7. Plug temperature sensors (A) into their sockets.
8. Insert the side interior walls on the left and right and tighten them with 8 screws each (Fig. 35). Reinsert the silicone plugs.

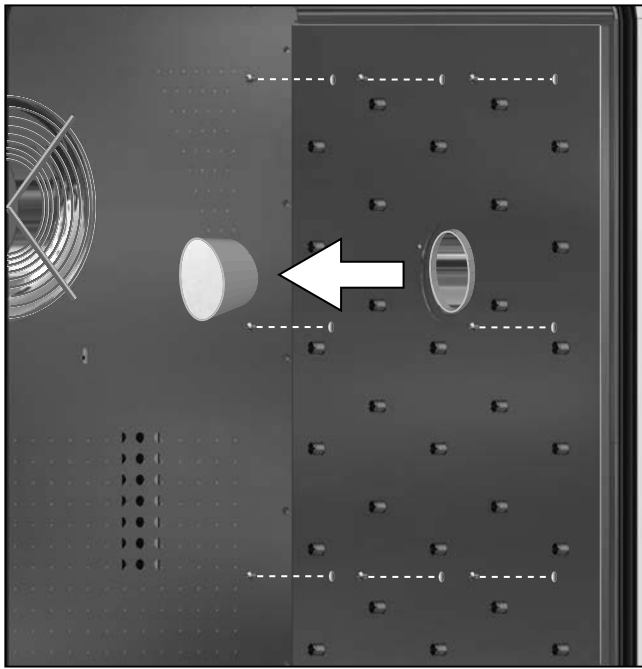

Fig. 35
Dismantling the right and left inner walls. Remove the silicone plugs and 8 screws on each side and pull out the wall.

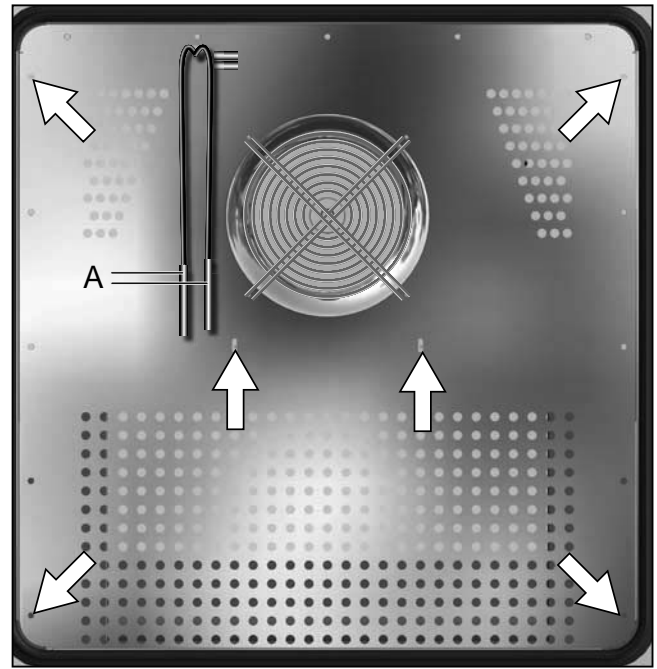

Fig. 36
Pull the temperature sensors (A) out of the holders and unscrew the test chamber rear wall

8.3 Regular maintenance

Every three months if in permanent operation

- ▶ Grease the moving parts of the doors (hinges and lock) with thin silicone grease and check that the hinge screws are not loose.
- ▶ Check that door seals fit tightly, adjust door if necessary (see Chapter 8.4).
- ▶ Check that the condensation water runoff tube (Fig. 37) at the rear of the chamber interior is not blocked and clean if necessary.

Every six months

- ▶ Check air filter of cooling unit for dirt and clean if necessary (see Chapter 8.5).

Annually:

- ▶ Clean air filter of cooling unit (see Chapter 8.5).
- ▶ Grease the moving parts of the doors (hinges and lock) with thin silicone grease and check that the hinge screws are not loose.
- ▶ Check that door seals fit tightly, adjust door if necessary (see Chapter 8.4).
- ▶ Check the safety labels and renew warning stickers if necessary (see Fig. 1 on page 7).

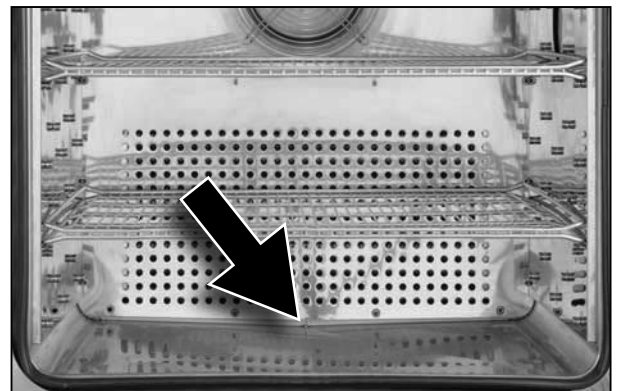

Fig. 37 Condensation water runoff tube

8.4 Adjust door

A well-closing door is indispensable for temperature and climatic test chambers. On Memmert appliances, the tight closing of the door is optimally guaranteed by a chamber seal and door seal. In permanent operation, it is possible that the flexible seal material will settle. To ensure that the door closes exactly despite this, an adjustment may be necessary:

1. Undo the grub screw with a Torx-TX8 tool (Fig. 38). This is fixed with locking paint and can be undone with a jolt.
2. Adjust door by turning the eccentric tappet (2) with a screwdriver.
3. Tighten the grub screw again.

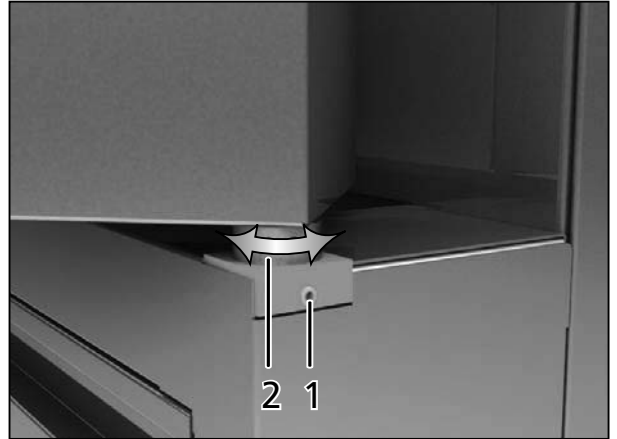

Fig. 38 Adjusting the door
1 Grub screw
2 Eccentric

The locking plate (Fig. 39) can also be adjusted:

1. Undo screws (1).
2. Move locking plate in direction of arrow.
3. Tighten the screws again.

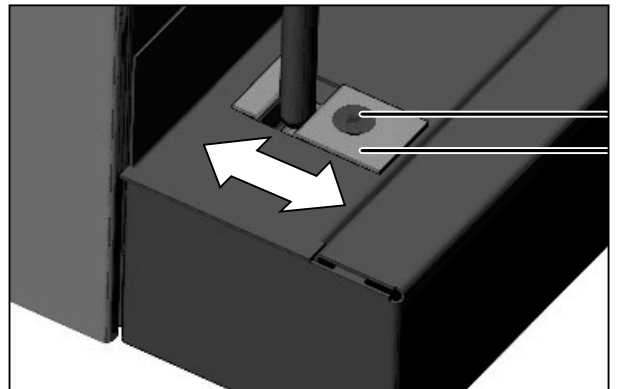

Fig. 39 Adjusting the locking plate
1 Undo screws

8.5 Removing / cleaning the air filter of the cooling unit

1. Open door
2. Remove and empty the drip tray (Fig. 40).
3. Pull out the filter by the handle on the top (Fig. 41).
4. Clean filter in a dishwasher or with a steam cleaner.
5. Push the filter back in and reinsert the drip tray.

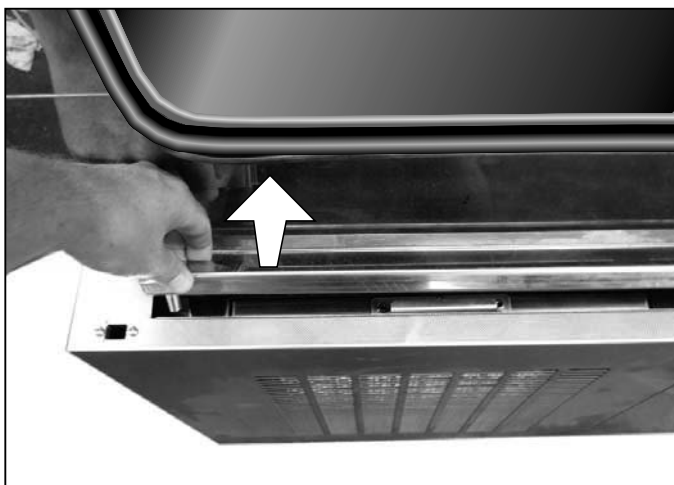

Fig. 40 Removing drip tray

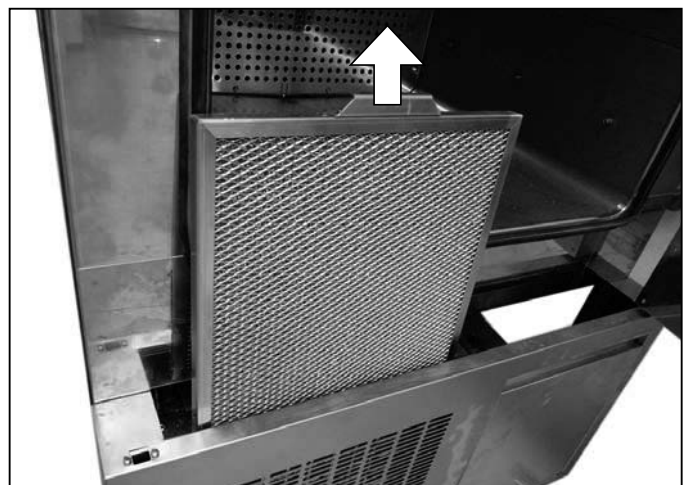

Fig. 41 Pulling out air filter

8.6 Replacing the interior lamps

1. Undo the four fixing screws of the glass plate on the ceiling of the interior and remove the glass plate (Fig. 42).
2. Replace the defective lamp with a standard new 25 watt halogen lamp.
3. Screw the glass plate back on. Make sure that the seal is properly mounted.

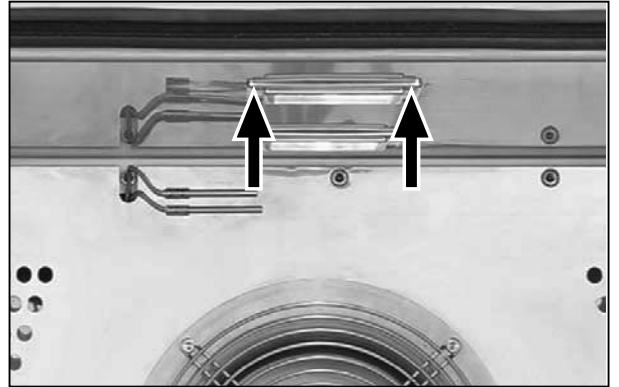

Fig. 42 Interior lighting

8.7 Repairs and Service



Warning!

After removing covers, voltage-carrying parts may be exposed. You may receive an electric shock if you touch these parts. Disconnect the mains plug before removing any covers. Any work inside the unit may only be performed by qualified electricians.

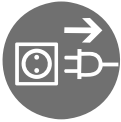

Repairs and service work are described in a separate service manual.

9. Storage and disposal

9.1 Storage

The test chamber may only be stored under the following conditions.

- ▶ dry and in an enclosed, dust-free room
- ▶ frost-free
- ▶ disconnected from the power supply

Before storage, empty the freshwater and condensation water tanks (see page 22).

9.2 Disposal

This product is subject to the Directive 2002/96/EC on Waste Electrical Electronic Equipment (WEEE) of the European Parliament and of the EU Council of Ministers. This appliance has been brought to market after August 13th, 2005 in countries which have already integrated this directive into their national laws. It may not be disposed of in normal household waste. To dispose, please contact your dealer or manufacturer. Any appliances that are infected, infectious or contaminated with materials that are a hazard to health are excluded from being taken back.

Please observe all other regulations in this context.

Note for Germany:

The appliance may not be left at public or communal recycling or collection points.

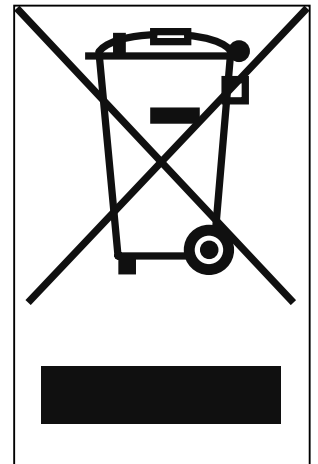

Index

- A**
Accidents 9
Acoustic signal 47
Adjust door 63
Air circulation 17
Air filter 62, 63
Air humidity 18
ALARM sound 47
Altitude of installation 18
Ambient temperature 18
Appliance errors 44
ASF 49
Automatic defrosting system 47, 54
Automatic temperature monitor 49
- B**
Basic appliance settings 46
Basic equipment 13
Basic operation 29
- C**
Cable feed-through 26
Calibration 51
Card reader 59
CD-ROM 56
Celsius 55
Cleaning the air filter 63
Clearance 20
Clock time 46
Close command of the ramp segment 37
Closing the door 25
Communication address 47
Communication interfaces 55
Compensation correction values 47, 53
Condensation 62
Condensation water runoff tube 62
Conformity 15
Connecting 23
Connections 18
Control 24
Controller 28
Conversions 8
Cool-down speed 12
Cooling /heating up speed 12, 13
Cooling unit 51
Current consumption 17
Customer service 2
- D**
Dangers 7
Date 47
Defrosting system 47, 54
Degree of protection 17
Delayed programme start 35
Delivery 19
Description 10
Design 10
Designation 16
Disposal 65
Disposing of packaging material 19
Door 25
Drip tray 63
- E**
EC Declaration of Conformity 15
Electrical equipment 17
Electronic temperature monitoring 48
Emergency 9
Ending operation 43
ENDSOUND 47
Environmental conditions 18
Error messages 44
Ethernet 56
Example of settings Week time switch 34
Example setting Normal mode 31
Example setting programming mode 39
- F**
Flash memory 60
Freshwater tanks 22
Fuses 17
- H**
Heat compensation 12
Humidity calibration 53
Humidity operation 11
- I**
Icing 54
ID-LOCK 60
Installation 20
Intended Use 14
Interfaces 55
Interior lamps 64
IP address 56
Irregularities 8
- J**
- K**
Key icon 60
- L**
Labelling 7
Lamps 64
Language 47
Laptop 21, 43
Laptop holder 21
Load 17
Loading 26
Lock 60
Log memory 45, 57
- M**
Maintenance 61
Malfunctions 8, 44
Manufacturer 2
Material 14
Memory 57
MEMoryCard 58
MEMoryCard XL 58
Minimum clearance 20
Monitoring 17
Monitoring temperature 48
- N**
Nameplate 16
Network 56
Networking 55
Noise level 17
Normal mode 30

- O**
Opening and closing the door 25
Operating modes 29
Operating mode - settings 30
Operating panel 28
Operating personnel 8
Operating staff 24
Operating voltage 17
Operation 24
- P**
PC 43
Performance 17
Power failure 45
Printer 46
Printout 57
Product safety 7
Programming mode 35
- R**
Ramp repeat function 38
Ramp segments 37
Read-write device 59
Regular maintenance 62
Repairs 64
Replacing the interior lamps 64
RS232 55
RS232/RS485 adapter 55
RS485 55
- S**
Safety class 17
Safety equipment 48
Safety Labelling 7
Safety regulations 6
Service 64
Servicing 61
SET-POINT WAIT 37
Setting parameters 29
Setting Up 19
Setup 46
Standard accessories 18
Storage 65
Storage after delivery 19
Storage space 59
Switching appliance on and off 27
Switch-on time 36
System/ appliance errors 44
- T**
Tank drawer 22, 24
Tanks 22
Technical data 17
Temperature calibration 51
Temperature monitoring 48
Temperature operation 11
Temperature sensor 21, 48
Tolerance band ASF 47
Transport 19
Transport damage 19
TWW 48
- U**
Unpacking 19
USB interface 55
User-ID-Card 60
- V**
Volume 17
- W**
Warm-up speed 13
Warning message 51
Warning stickers 7
Water specifications 22
Weekday 47
Week time switch 33
Weight 17
Working range 12
- X**
XTADMIN 56
- Y**
Year 47

