

Verderflex

VP2-B basic flow tube pump



VERDERFLEX®

Description

Peristaltic tube pump with fixed flow. Maximum flow 20 l/h.

Materials

Pump body	PP body reinforced with 30% fiberglass
Max pressure	1 bar (Santoprene tubing) 3 bar (Silicon tubing)
Power supply	230 VAC - 24 VDC
Connections	PP 1/8"
Fittings	PP 4 x 6 mm

Detergent installation kit	detergent	rinse aid
Suction tube	PVC 4 x 6	PVC 4 x 6
Delivery tube	PVC 4 x 6	PE 4 x 6
Injection valve	PP 90°	Steel 1/8"
Foot filter	Steel rubber holder	Steel rubber holder

Technical data

	Max l/h	Pressure bar	Max cc/min	Max operating temperature °C	Tubing material	Tube ø mm	Pump body material	Power c Watt	rpm	Weight kg
230 VAC										
1.5 - 01	1.5	1	25	65	Santoprene	5.8 x 9.4	PP	35	10	0.5
03-01	3	1	50	65	Santoprene	5.8 x 9.4	PP	35	20	0.5
04-01	4	1	66.67	65	Santoprene	5.8 x 9.4	PP	35	30	0.5
06-01	6	1	100	65	Santoprene	5.8 x 9.4	PP	35	40	0.5
01-03	1	3	16.67	65	Silicon	5 x 10	PP	35	10	0.5
24 VDC										
1.5 - 01	1.5	1	25	65	Santoprene	5.8 x 9.4	PP	35	10	0.5
03-01	3	1	50	65	Santoprene	5.8 x 9.4	PP	35	20	0.5
04-01	4	1	66.67	65	Santoprene	5.8 x 9.4	PP	35	30	0.5
06-01	6	1	100	65	Santoprene	5.8 x 9.4	PP	35	40	0.5
12-01	12	1	200	65	Santoprene	5.8 x 9.4	PP	35	102	0.5
20-01	20	1	334	65	Santoprene	5.8 x 9.4	PP	35	160	0.5
01-03	1	3	16.67	65	Silicon	5 x 10	PP	35	20	0.5

Verderflex

VP2-B basic flow tube pump



VERDERFLEX®

Dimensions

(in mm)

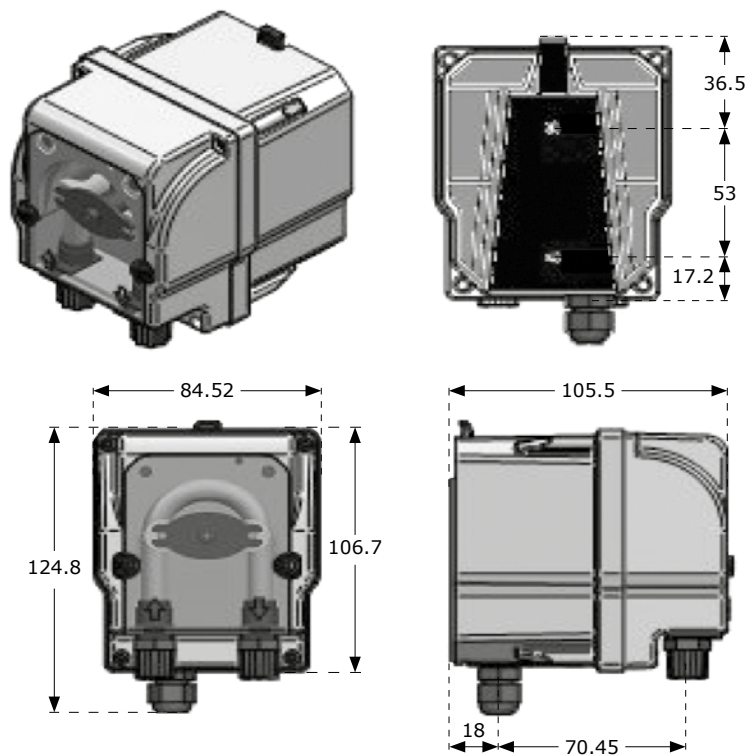

Standard accessories kit

1/2" PP-VL-VT Lip	Foot Filter PP-VL-VT	Suction tube 2 m PVC 4x6	Delivery tube 2 m PE 4x6

flex_VP2-B_2021_rev2_UK-(uk)



Find your local supplier
at www.verderflex.com

For construction, installation and mounting drawings
please contact your local authorised Verderdos distributor.

VERDER
passion for pumps